

# Frigerio

## VIEW SOFA

Design Ferruccio Laviani

Ferruccio Laviani consolida la collaborazione con Frigerio ampliando la collezione del divano modulare moderno View, con nuovi moduli compositivi e inediti accessori per l'area living. Sintesi perfetta dell'estro creativo del designer e del know-how decennale dell'azienda nel settore degli imbottiti, View è un divano modulare che si compone di moduli diversi combinabili tra loro con disinvoltura: la versione modulare con base del divano nella versione piattaforma, in legno o laccata lucida, o la versione modulare a terra imbottita, dialogano fra loro e con l'importante numero di elementi, alcuni dall'animo classico altri dal design più originale. Per la piattaforma in legno, due nuovi colori laccati lucidi si aggiungono alle tinte a catalogo e si consolida la personalizzazione grazie ad accessori come volumi imbottiti, elementi libreria integrati, tavolini fianco e fronte divano.

Ferruccio Laviani consolidates his collaboration with Frigerio by enlarging the View modern modular sofa collection with new modular elements and brand-new accessories for the living area. A perfect synthesis of the designer's creative flair and the company's decades of know-how in the upholstered furniture sector, View is modular sofa made of different elements that can be combined with ease: the sofa version with platform base, in wood and either glossy lacquered or upholstered on floor, they dialogue with each other and with a large number of elements, some with a classic taste, others with a more original design. For the wooden platform, two new glossy lacquered colours are added to the collection by adding to personalized accessories such as padded volumes, integrated bookcase elements, side and front small tables.



### VERSIONE VIEW SOFT

**Struttura:** legno multistrato imbottito in poliuretano espanso indeformabile rivestito in tessuto protettivo accoppiato.

**Braccioli:** pezzo unico con la struttura del divano.

**Cuscini seduta:** accoppiato a fibra sintetica.

**Cuscini schienale:** poliuretano espanso indeformabile.

**Piedini:** neri.

**Rivestimento:** sfoderabile in tessuto, fisso in pelle.

**Profilo:** esclusivamente sul cuscino seduta, nello stesso materiale e colore del rivestimento. Su richiesta profilo in contrasto in Grosgrain.

### VERSIONE VIEW PLATFORM

**Base:** in frassino o in laccato lucido.

**Schienali:** in legno di multistrato imbottito in poliuretano espanso indeformabile rivestito in tessuto protettivo accoppiato con fissaggio a baionetta sulla base.

**Braccioli:** in legno di multistrato imbottito in poliuretano espanso indeformabile rivestito in tessuto protettivo accoppiato con fissaggio a baionetta sulla base.

### VERSIONE VIEW PLATFORM TOP

- **Top 45:** elementi terminali, centrali, chaise longue e terminali angolo con base top in frassino o laccato lucido.

**ACCESSORI PER VIEW PLATFORM TOP 45 cm:**

| **volume soft:** tessuto o pelle.

| **libreria:** legno di frassino o laccato lucido.

- **Top 75:** elementi terminali, centrali, chaise longue e terminali angolo con base in top di frassino o laccato lucido.

### ACCESSORI

| **libreria:** freestanding per posizionamento come elemento retro divano in frassino o laccato lucido.

### VERSIONE VIEW SOFT

**Structure:** plywood padded with non-deformable polyurethane foam covered with doubled protective fabric.

**Armrests:** unique piece with the sofa structure.

**Seat cushions:** non-deformable polyurethane foam.

**Back cushions:** goose down (Assopiuma).

**Feet:** black.

**Cover:** removable in fabric, fixed in leather.

**Piping:** on seat cushion only, in the same material and colour as the cover. On demand piping in contrast in Grosgrain.

### VERSIONE VIEW PLATFORM

**Base:** in ashwood or glossy lacquered.

**Backrests:** in plywood padded with non-deformable polyurethane foam covered with doubled protective fabric, with bayonet fastening on the base.

**Armrests:** plywood padded with non-deformable polyurethane foam covered with doubled protective fabric, with bayonet fastening on the base.

### VERSIONE VIEW PLATFORM TOP

- **Top 45:** terminal, central, chaise longue, terminal corner elements with top base in ashwood or glossy lacquered.

**ACCESSORIES FOR VIEW PLATFORM TOP 45 cm:**

| **volume soft:** fabric or leather.

| **libreria:** ashwood or glossy lacquered.

- **Top 75:** terminal, central, chaise longue, terminal corner elements with top base in ashwood or glossy lacquered.

### ACCESSORIES

| **bookcase:** freestanding in ashwood or glossy lacquered to be placed at the back of the sofa.

## VIEW COLLECTION



### VIEW SOFT

View Soft è una collezione di elementi centrali con struttura imbottita a terra a cui possono essere aggiunti elementi braccioli o schienali.

View Soft is a collection of central element with padded base on floor to which armrests or backrests can be added.



### VIEW PLATFORM

View Platform è una collezione di divani ed elementi componibili con struttura costituita da una piattaforma in legno e da una versione classica del bracciolo.

View Platform is a collection of sofas and elements for compositions with a wooden platform as structure, and with a classic armrest version.



### VIEW PLATFORM TOP

View Platform Top presenta gli elementi caratterizzati dalla piattaforma in legno che sporgono dagli stessi creando un top utilizzabile per l'appoggio di accessori.

View Platform Top features the wooden platform that extends from them, creating a top that can be used to support accessories.

## VIEW ACCESSORI / ACCESSORIES



**BRACCIOLO VIEW SOFT VLS /**  
ARMREST VIEW SOFT VLS



**SCHIENALE VIEW SOFT VHL /**  
BACKREST VIEW SOFT VHL



**BRACCIOLO VIEW PLATFORM /**  
ARMREST VIEW PLATFORM



**VOLUME SOFT**



**BOOKCASE**



**TOP 45 CM**



**TOP 75 CM**

## VIEW SOFT SOFA

Design Ferruccio Laviani

### VIEW SOFT / d. 105 cm

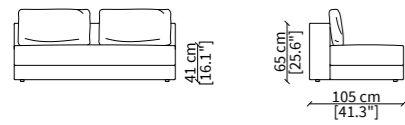

### BRACCIOLO / ARMREST

#### 19000 - VLS



### SCHIENALE / BACKREST

#### 19001 - VHL

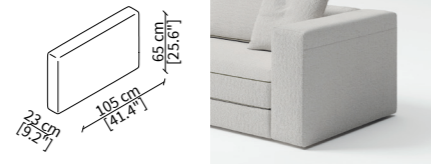

### ELEMENTI CENTRALI / CENTRAL ELEMENTS

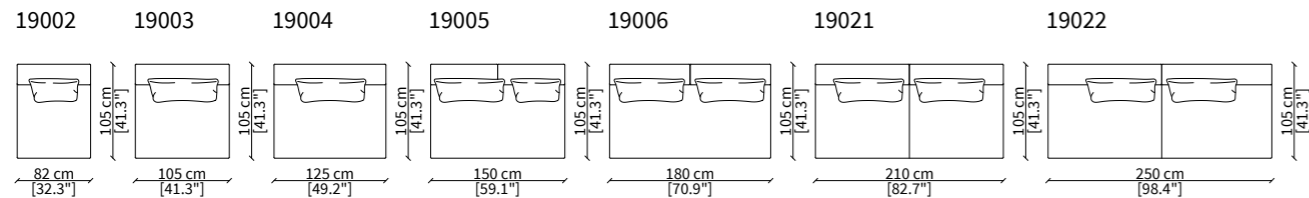

### DORMEUSES

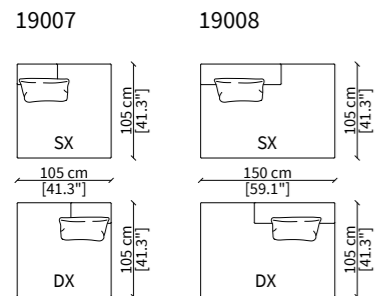

### DORMEUSE LONGUE

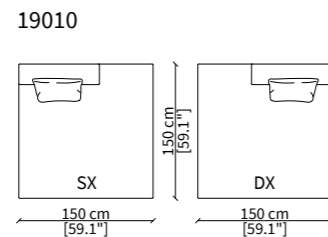

### DORMEUSE PENTAGONALE / PENTAGONAL DORMEUSE

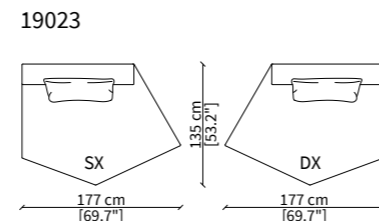

### ELEMENTO COMFORT / COMFORT ELEMENT

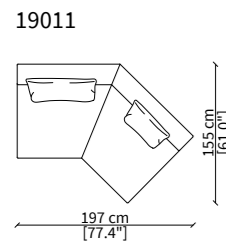

### DORMEUSE COMFORT

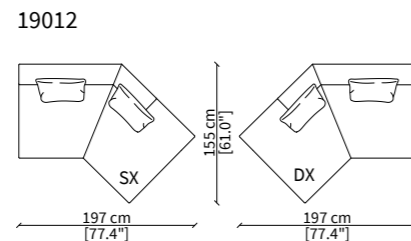

### CHAIRES LONGUE

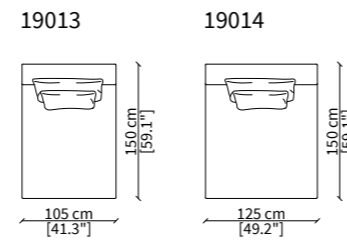

Dimensioni espresse in cm se non diversamente indicato.  
L'Azienda si riserva il diritto di apportare modifiche ai modelli senza preavviso.  
Tolleranza sulle misure indicate di +/- 2%.

Dimensions in centimeter if not differently indicated.  
The Company reserves the right to change the models without any advance notice.  
Tolerance on the given sizes +/- 2%.

## VIEW SOFT SOFA

Design Ferruccio Laviani

### ANGOLO APERTO / OPEN CORNER

#### 19015

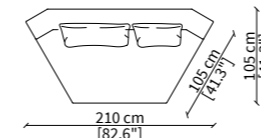

### DORMEUSE ESAGONALE / HEXAGONAL DORMEUSE

#### 19025

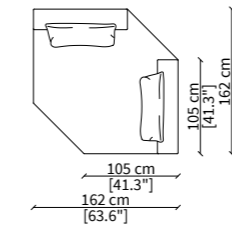

### POUFS

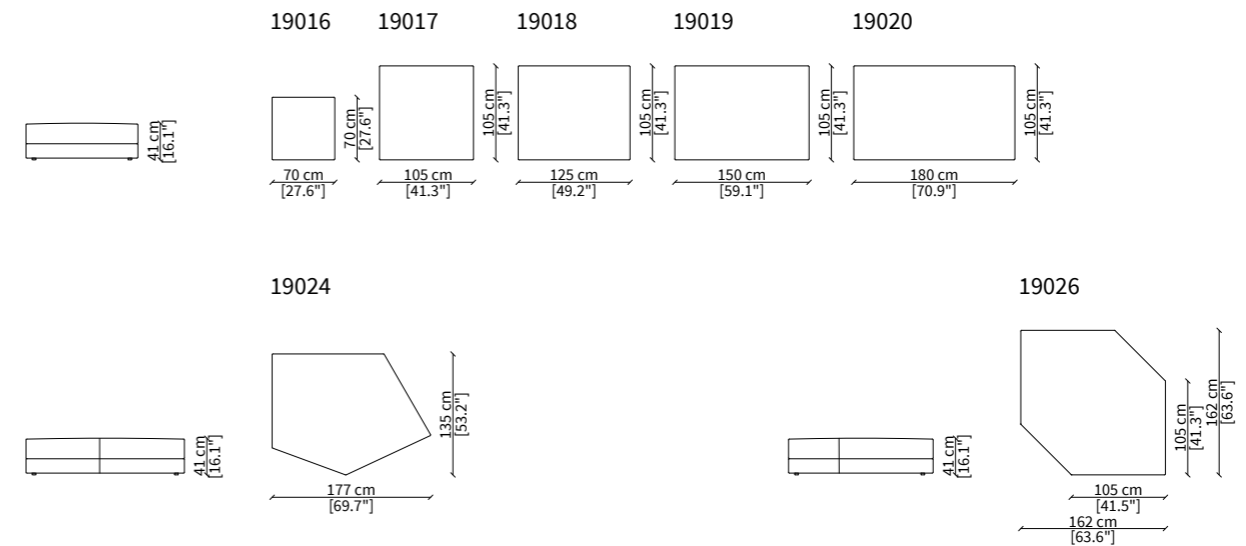

### CUSCINI / CUSHIONS



Dimensioni espresse in cm se non diversamente indicato.  
L'Azienda si riserva il diritto di apportare modifiche ai modelli senza preavviso.  
Tolleranza sulle misure indicate di +/- 2%.

Dimensions in centimeter if not differently indicated.  
The Company reserves the right to change the models without any advance notice.  
Tolerance on the given sizes +/- 2%.

## VIEW SOFT SOFA

Design Ferruccio Laviani

### DETTAGLI DELLO SCHIENALE VHL / DETAILS OF BACKREST VHL

#### 19001 - VHL

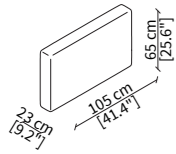

**VHL:** Schienale aggiuntivo con le stesse caratteristiche dello schienale per essere usato nelle composizioni ad angolo.

**VHL:** Additional backrest with same characteristics as the backrest, to be used in corner composition.

### ESEMPI DI COMPOSIZIONE AD ANGOLO / EXAMPLES OF CORNER COMPOSITIONS

Le composizioni ad angolo possono essere così realizzate:  
Corner composition can be built as follows:

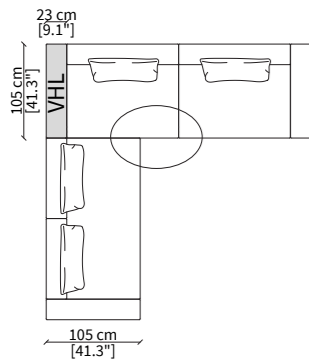

1. creando un angolo unendo qualsiasi elemento allo schienale **VHL (19001)**. Sugeriamo l'aggiunta di un cuscino schienale per maggiore comfort nell'angolo.

1. by building a corner joining any elements to the backrest **VHL (19001)**. We recommend adding an extra back cushion for a better comfort in the corner.

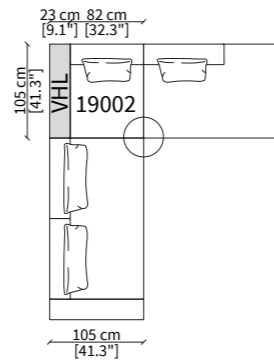

2. creando un angolo quadro (cm 105 x 105) unendo l'elemento **19002** (cm 82) allo schienale **VHL (19001)** cm 23) per un allineamento preciso delle sedute.

2. by building a square corner (cm 105 x 105) joining the element **19002** (cm 82) to the backrest **VHL (19001)** cm 23) for a perfect alignment of the seats.

### ESEMPIO DI COMPOSIZIONE CON DORMEUSE ESAGONALE / EXAMPLE OF COMPOSITION WITH HEXAGONAL DORMEUSE

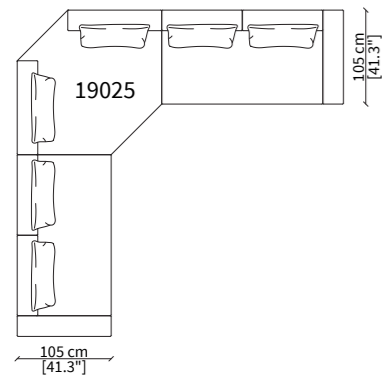

Dimensioni espresse in cm se non diversamente indicato.  
L'Azienda si riserva il diritto di apportare modifiche ai modelli senza preavviso.  
Tolleranza sulle misure indicate di +/- 2%.

Dimensions in centimeter if not differently indicated.  
The Company reserves the right to change the models without any advance notice.  
Tolerance on the given sizes +/- 2%.

## VIEW SOFT SOFA

Design Ferruccio Laviani

### COMPOSIZIONE 1 / COMPOSITION 1

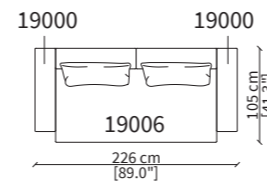

CODICI / CODES: **19000 x 2, 19006**

### COMPOSIZIONE 2 / COMPOSITION 2

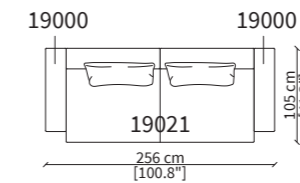

CODICI / CODES: **19000 x 2, 19021**

### COMPOSIZIONE 3 / COMPOSITION 3

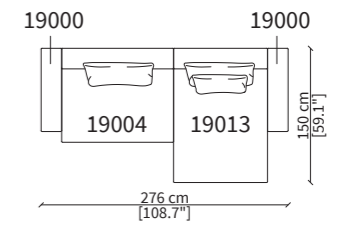

CODICI / CODES: **19000 x 2, 19004, 19013**

### COMPOSIZIONE 4 / COMPOSITION 4

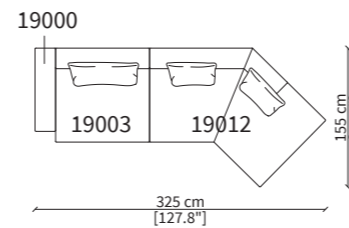

CODICI / CODES: **19000, 19003, 19012**

### COMPOSIZIONE 5 / COMPOSITION 5

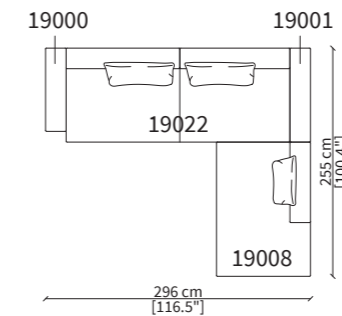

CODICI / CODES: **19000, 19022, 19008, 19001**

### COMPOSIZIONE 6 / COMPOSITION 6

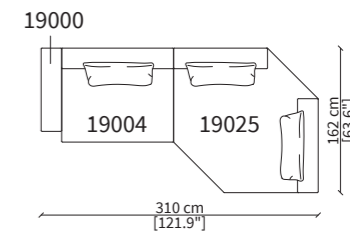

CODICI / CODES: **19000, 19004, 19025**

### COMPOSIZIONE 7 / COMPOSITION 7

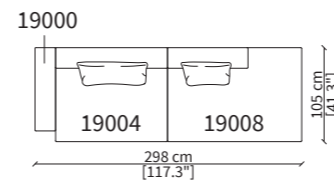

CODICI / CODES: **19000, 19004, 19008**

### COMPOSIZIONE 8 / COMPOSITION 8

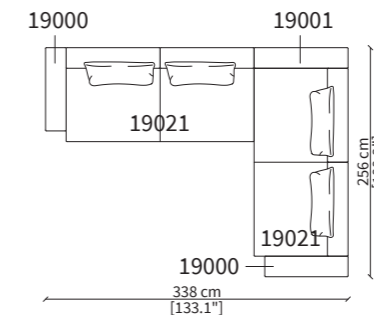

CODICI / CODES: **19000 x 2, 19001, 19021 x 2**

### COMPOSIZIONE 9 / COMPOSITION 9

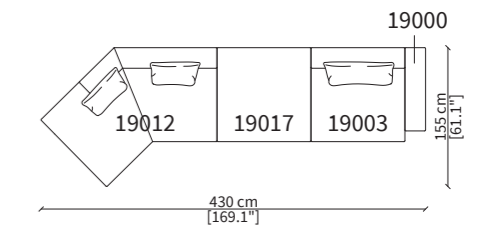

CODICI / CODES: **19012, 19017, 19003, 19000**

### COMPOSIZIONE 10 / COMPOSITION 10

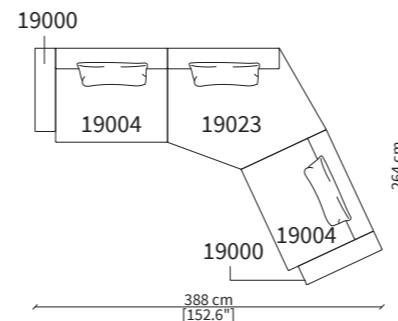

CODICI / CODES: **19000 x 2, 19004, 19023, 19004**

### COMPOSIZIONE 11 / COMPOSITION 11

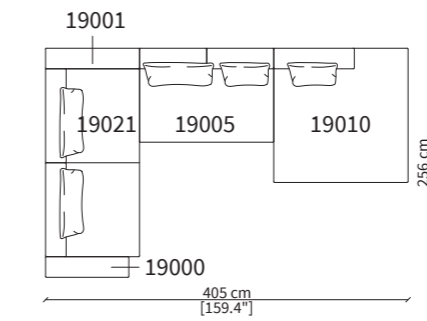

CODICI / CODES: **19000, 19001, 19021, 19005, 19010**

### COMPOSIZIONE 12 / COMPOSITION 12

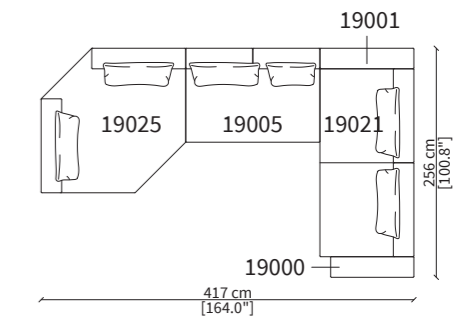

CODICI / CODES: **19025, 19005, 19001, 19021, 19000**

## VIEW PLATFORM SOFA

Design Ferruccio Laviani

### VIEW PLATFORM / d. 105 cm

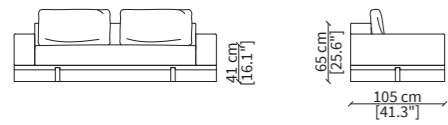

## DIVANI / SOFAS

### 19100

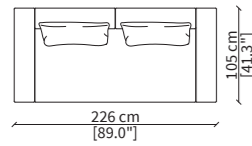

## ELEMENTI TERMINALI / TERMINAL ELEMENTS

### 19101

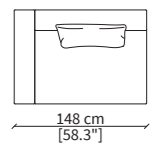

### 19102

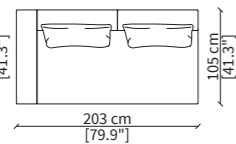

## ELEMENTI CENTRALI / CENTRAL ELEMENTS

### 19103

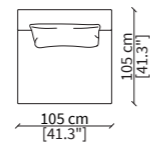

### 19104

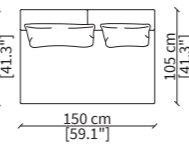

## CHAISE LONGUE

### 19105

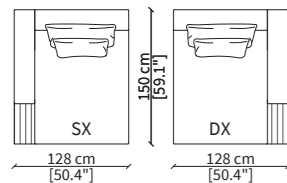

## CHAISE LONGUE CENTRALE / CENTRAL CHAISE LONGUE

### 19106

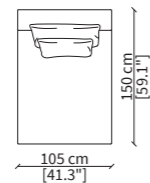

## DORMEUSE ESAGONALE / HEXAGONAL DORMEUSE

### 19107

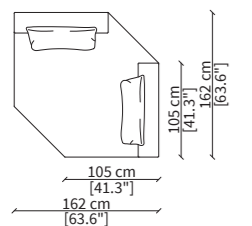

## DORMEUSE ESAGONALE / HEXAGONAL DORMEUSE

### 19139

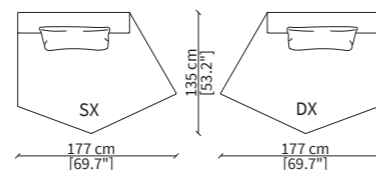

Dimensioni espresse in cm se non diversamente indicato.  
L'Azienda si riserva il diritto di apportare modifiche ai modelli senza preavviso.  
Tolleranza sulle misure indicate di +/- 2%.

Dimensions in centimeter if not differently indicated.  
The Company reserves the right to change the models without any advance notice.  
Tolerance on the given sizes +/- 2%.

## VIEW PLATFORM SOFA

Design Ferruccio Laviani

### ANGOLO / CORNER

#### 19108

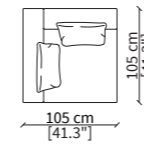

### TERMINALE ANGOLO / TERMINAL CORNER

#### 19109

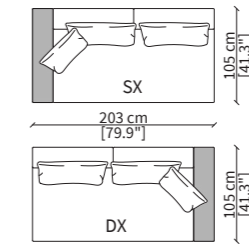

## POUFS

### 19123



### 19124

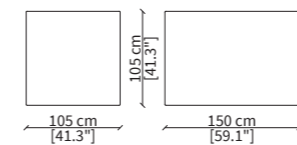

### 19125

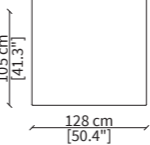

### 19126

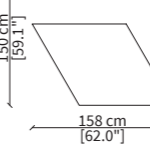

### 19127

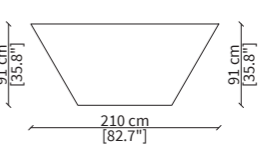

### 19128

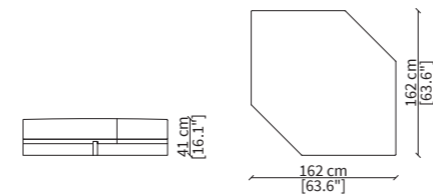

### 19140

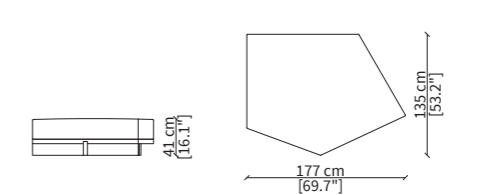

## TAVOLINI / SMALL TABLES

### 19129



### 19130

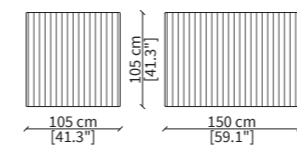

### 19131

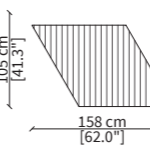

### 19132

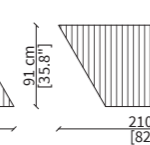

### 19133

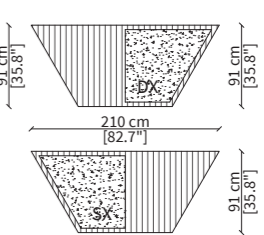

## LIBRERIA RETRO-DIVANO / BOOKCASE FOR BACKREST

### 19137

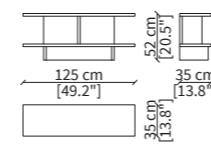

### 19138

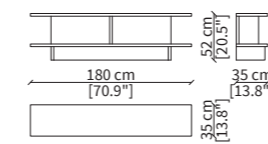

## CUSCINI / CUSHIONS

### GV



### IV



### MV



### 7441



### 7442

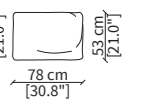

Dimensioni espresse in cm se non diversamente indicato.  
L'Azienda si riserva il diritto di apportare modifiche ai modelli senza preavviso.  
Tolleranza sulle misure indicate di +/- 2%.

Dimensions in centimeter if not differently indicated.  
The Company reserves the right to change the models without any advance notice.  
Tolerance on the given sizes +/- 2%.

## VIEW PLATFORM TOP SOFA

Design Ferruccio Laviani

### VIEW PLATFORM TOP / d. 105 cm

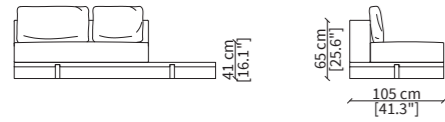

#### TOP 45



#### TOP 75



### TERMINALI TOP 45 / TERMINALS TOP 45

19110

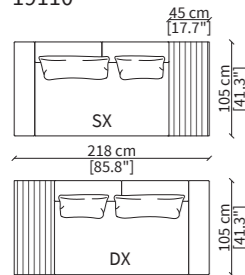

19111

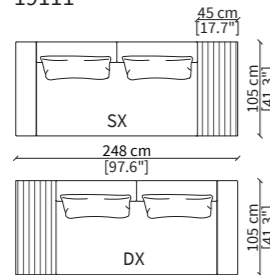

### TERMINALI TOP 75 / TERMINALS TOP 75

19112

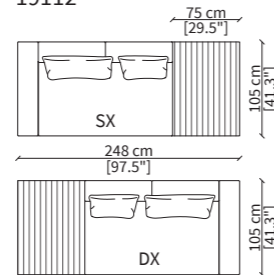

### CENTRALI TOP 45 / CENTRALS TOP 45

19114

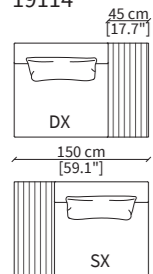

19115

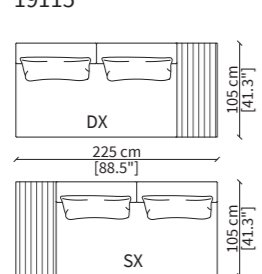

### CENTRALI TOP 75 / CENTRALS TOP 75

19116

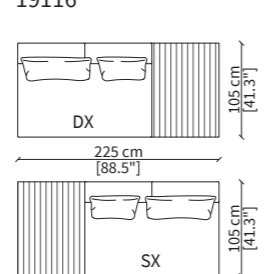

### CHAISE LONGUE GEOMETRICA TOP / GEOMETRICAL CHAISE LONGUE TOP

19136

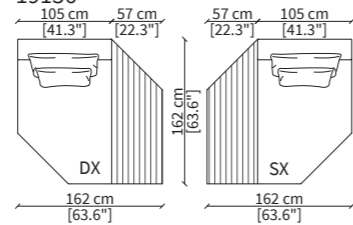

Dimensioni espresse in cm se non diversamente indicato.  
L'Azienda si riserva il diritto di apportare modifiche ai modelli senza preavviso.  
Tolleranza sulle misure indicate di +/- 2%.

Dimensions in centimeter if not differently indicated.  
The Company reserves the right to change the models without any advance notice.  
Tolerance on the given sizes +/- 2%.

## VIEW PLATFORM TOP SOFA

Design Ferruccio Laviani

### TERMINALE ANGOLO TOP 45 / TERMINAL CORNER TOP 45

19119

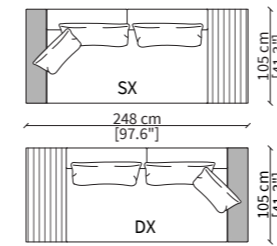

### TERMINALE ANGOLO TOP 75 / TERMINAL CORNER TOP 75

19120

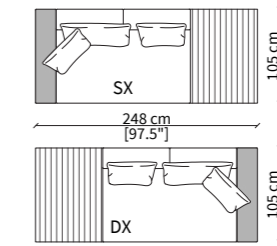

### POUF TOP 45

19108

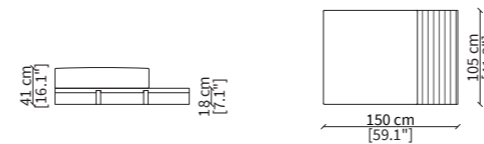

### ACCESSORI TOP / TOP ACCESSORIES

#### 19134 - VOLUME SOFT

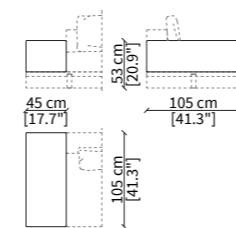

#### 19135 - LIBRERIA / BOOKCASE

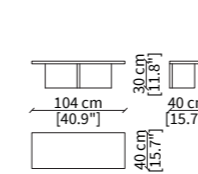

Dimensioni espresse in cm se non diversamente indicato.  
L'Azienda si riserva il diritto di apportare modifiche ai modelli senza preavviso.  
Tolleranza sulle misure indicate di +/- 2%.

Dimensions in centimeter if not differently indicated.  
The Company reserves the right to change the models without any advance notice.  
Tolerance on the given sizes +/- 2%.

## VIEW PLATFORM SOFA

Design Ferruccio Laviani

### DIFFERENZA TRA TERMINALE E TERMINALE ANGOLO / DIFFERENCE BETWEEN TERMINAL AND TERMINAL CORNER



- A:** Terminale                      **B:** Terminale angolo  
**A:** Terminal                          **B:** Terminal corner

### ESEMPI DI COMPOSIZIONE AD ANGOLO / EXAMPLES OF CORNER COMPOSITIONS

Le composizioni ad angolo possono essere così realizzate:  
Corner composition can be built as follows:

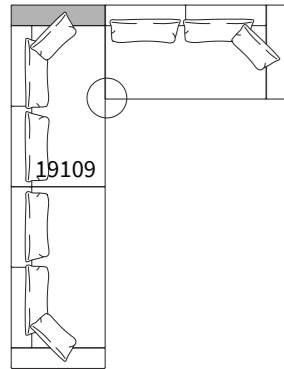

- utilizzando l'elemento "terminale angolo" (art. **19109**).
- by using the element "terminal corner" (art. **19109**).

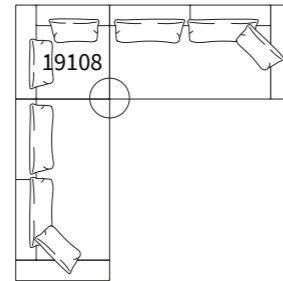

- utilizzando l'angolo (art. **19108**) per un allineamento preciso delle sedute.
- by using the corner (art. **19108**) for a perfect alignment of the seats.

### ESEMPIO DI COMPOSIZIONE CON DORMEUSE ESAGONALE / EXAMPLE OF COMPOSITION WITH HEXAGONAL DORMEUSE

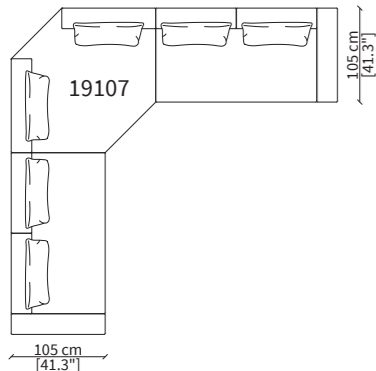

Dimensioni espresse in cm se non diversamente indicato.  
L'Azienda si riserva il diritto di apportare modifiche ai modelli senza preavviso.  
Tolleranza sulle misure indicate di +/- 2%.

Dimensions in centimeter if not differently indicated.  
The Company reserves the right to change the models without any advance notice.  
Tolerance on the given sizes +/- 2%.

## VIEW PLATFORM TOP SOFA

Design Ferruccio Laviani

### DIFFERENZA TRA TERMINALE TOP E TERMINALE ANGOLO TOP / DIFFERENCE BETWEEN TERMINAL TOP AND TERMINAL CORNER TOP



- A:** Terminale top                      **B:** Terminale angolo top  
**A:** Terminal top                          **B:** Terminal corner top

### ESEMPI DI COMPOSIZIONE AD ANGOLO / EXAMPLES OF CORNER COMPOSITIONS

Le composizioni ad angolo possono essere così realizzate:  
Corner composition can be built as follows:

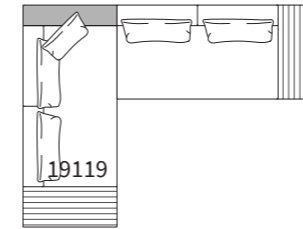

- utilizzando l'elemento "terminale angolo top" (art. **19119 - 19120**).
- by using the element "terminal corner top" (art. **19119 - 19120**).

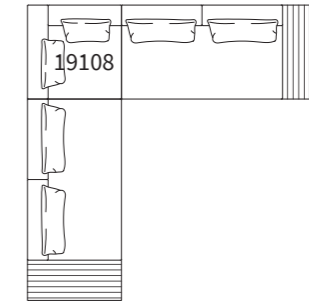

- utilizzando l'angolo (art. **19108** View Platform) per un allineamento preciso delle sedute.
- by using the corner (art. **19108** View Platform) for a perfect alignment of the seats.

Dimensioni espresse in cm se non diversamente indicato.  
L'Azienda si riserva il diritto di apportare modifiche ai modelli senza preavviso.  
Tolleranza sulle misure indicate di +/- 2%.

Dimensions in centimeter if not differently indicated.  
The Company reserves the right to change the models without any advance notice.  
Tolerance on the given sizes +/- 2%.

## VIEW PLATFORM - PLATFORM TOP SOFA

Design Ferruccio Laviani

### COMPOSIZIONE 1 / COMPOSITION 1

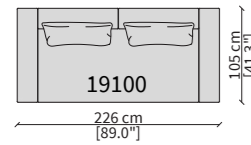

CODICI / CODES: **19100**

### COMPOSIZIONE 2 / COMPOSITION 2

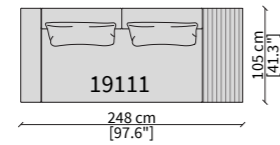

CODICI / CODES: **19111**

### COMPOSIZIONE 3 / COMPOSITION 3

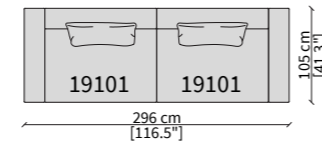

CODICI / CODES: **19101 x 2**

### COMPOSIZIONE 4 / COMPOSITION 4

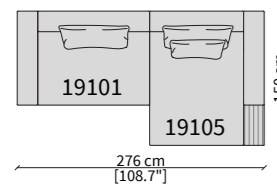

CODICI / CODES: **19101, 19105**

### COMPOSIZIONE 5 / COMPOSITION 5

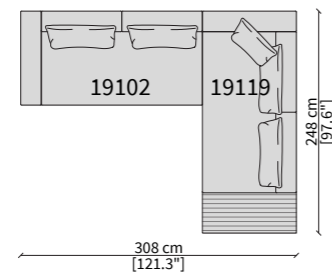

CODICI / CODES: **19102, 19119**

### COMPOSIZIONE 6 / COMPOSITION 6

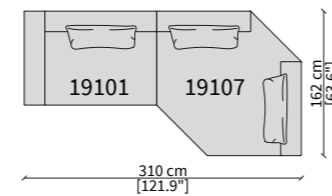

CODICI / CODES: **19101, 19107**

### COMPOSIZIONE 7 / COMPOSITION 7

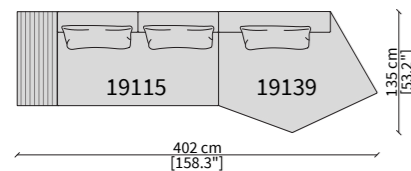

CODICI / CODES: **19115, 19139**

### COMPOSIZIONE 8 / COMPOSITION 8

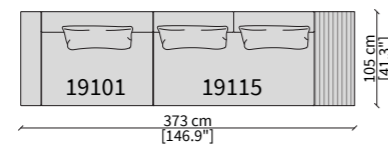

CODICI / CODES: **19101, 19115**

### COMPOSIZIONE 9 / COMPOSITION 9

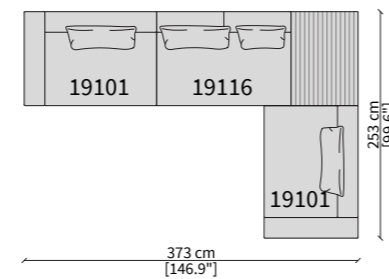

CODICI / CODES: **19101 x 2, 19116**

### COMPOSIZIONE 10 / COMPOSITION 10

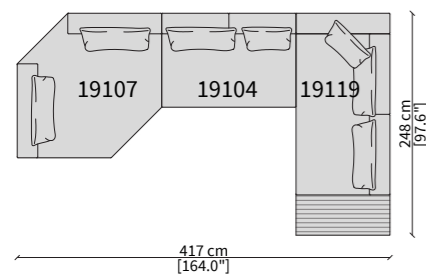

CODICI / CODES: **19107, 19104, 19119**

Dimensioni espresse in cm se non diversamente indicato.  
L'Azienda si riserva il diritto di apportare modifiche ai modelli senza preavviso.  
Tolleranza sulle misure indicate di +/- 2%.

Dimensions in centimeter if not differently indicated.  
The Company reserves the right to change the models without any advance notice.  
Tolerance on the given sizes +/- 2%.

## VIEW SOFT - PLATFORM - PLATFORM TOP SOFA

Design Ferruccio Laviani

### COMPOSIZIONE 1 / COMPOSITION 1

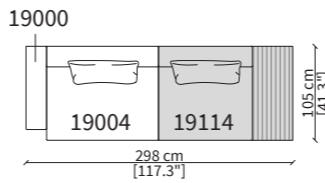

CODICI / CODES: **19000, 19004, 19114**

### COMPOSIZIONE 2 / COMPOSITION 2

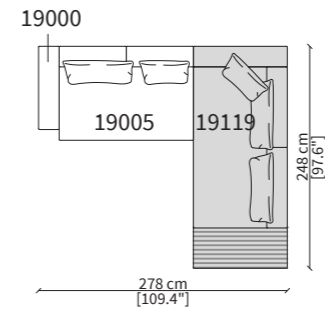

CODICI / CODES: **19000, 19005, 19119**

### COMPOSIZIONE 3 / COMPOSITION 3

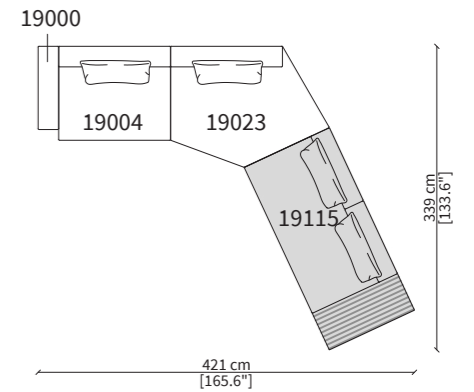

CODICI / CODES: **19000, 19004, 19023, 19115**

### COMPOSIZIONE 4 / COMPOSITION 4

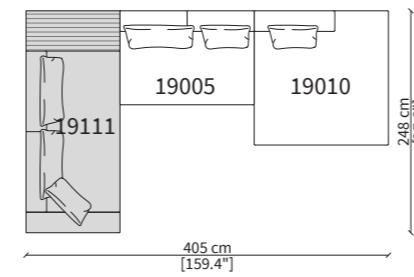

CODICI / CODES: **19111, 19005, 19010**

### COMPOSIZIONE 5 / COMPOSITION 5

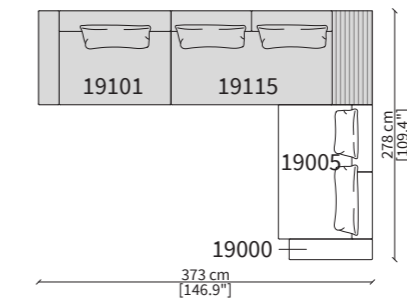

CODICI / CODES: **19101, 19115, 19005, 19000**

### COMPOSIZIONE 6 / COMPOSITION 6

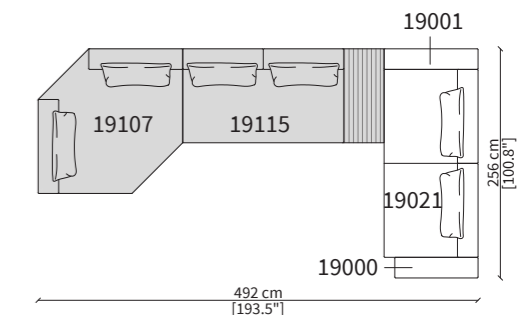

CODICI / CODES: **19107, 19115, 19001, 19021, 19000**

Dimensioni espresse in cm se non diversamente indicato.  
L'Azienda si riserva il diritto di apportare modifiche ai modelli senza preavviso.  
Tolleranza sulle misure indicate di +/- 2%.

Dimensions in centimeter if not differently indicated.  
The Company reserves the right to change the models without any advance notice.  
Tolerance on the given sizes +/- 2%.



Per la gamma completa di materiali è possibile consultare il nostro sito web [www.frigerio.com](http://www.frigerio.com)  
The full range of materials can be found on our website at [www.frigerio.com](http://www.frigerio.com).

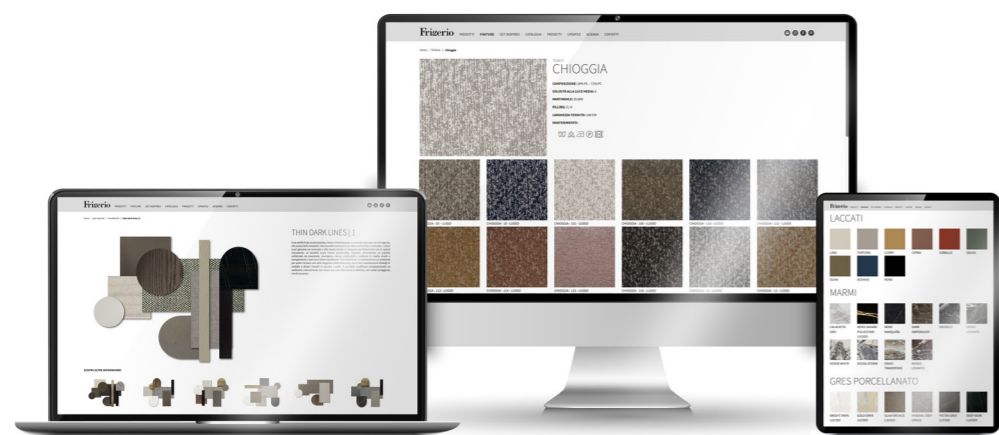

[WWW.FRIGERIO.COM](http://WWW.FRIGERIO.COM)

# Frigerio

Via Sant'Agata 63  
22066 Mariano Comense (CO) - Italy  
Tel. +39 031 5481225  
[info@frigerio.com](mailto:info@frigerio.com)  
[www.frigerio.com](http://www.frigerio.com)