

# Frigerio

## TAYLOR POUF

Design R&D Frigerio

Oggetto d'arredo versatile: pouf poggiapiedi, seduta extra e tavolino pensato per abbinarsi alla collezione omonima di divani, il pouf Taylor è proposto in forma quadrata o rettangolare, in più dimensioni, tutte disponibili con o senza piano laterale d'appoggio rivestito in cuoio. Morbido nel cuscino di seduta in piuma d'oca ha struttura in legno con imbottitura in poliuretano che appoggia sul basamento in metallo.

Versatile furnishing object: foot resting pouf, additional seating and small table thought to match the namesake sofa's collection, the Taylor pouf is proposed in square or rectangular shapes, in different dimensions all available with or without side shelf, which is covered in hide leather. The soft cushion in goose down has a wooden structure padded with polyurethane which is placed on a metal base.



## TAYLOR POUF

**Struttura:** legno multistrato imbottito in poliuretano espanso indeformabile rivestito con trapuntino in piuma d'oca (Assopiuma).

**Basamento:** metallo color nero lucido.

**Rivestimento:** con cucitura Pizzicotto, sfoderabile in tessuto, fisso in pelle.

**Mensole:** ricoperte in Cuoio con cuciture tono su tono e bordi impiallacciati color Wengé.

**Structure** plywood padded with non-deformable polyurethane foam covered with quilt in goose down (Assopiuma).

**Base:** metal glossy black colour.

**Cover:** with Pizzicotto sewing, removable in fabric, fix in leather.

**Shelves:** covered in hide-leather art. Cuoio with stitches tone-on-tone and edges colour Wengé.

## TAYLOR MEDIUM SOFA

Design R&D Frigerio

### TAYLOR MEDIUM FIX BACK / d. 102 cm

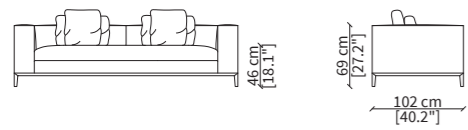

### DIVANI / SOFAS

12900 12901 12902 12903

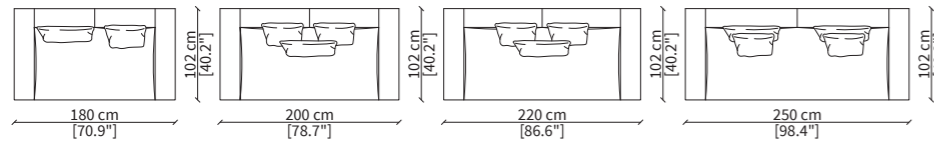

### DIVANO PER TOP / SOFA FOR TOP

12904

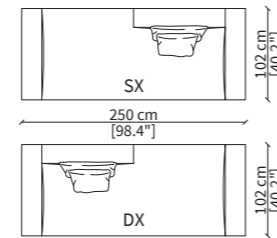

### ELEMENTI TERMINALI / TERMINAL ELEMENTS

12905 12906 12907 12908

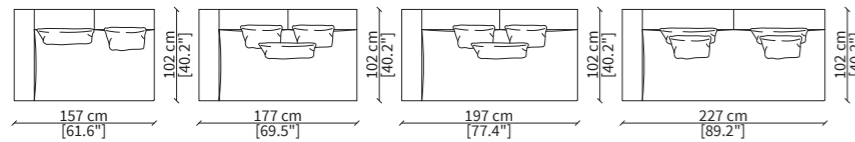

### ELEMENTI CENTRALI / CENTRAL ELEMENTS

12909 12910 12911

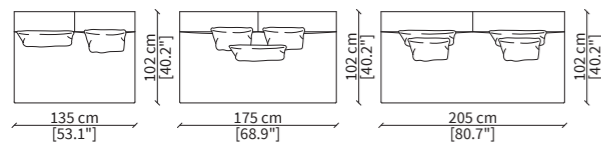

### DORMEUSES

12912 12913 12914

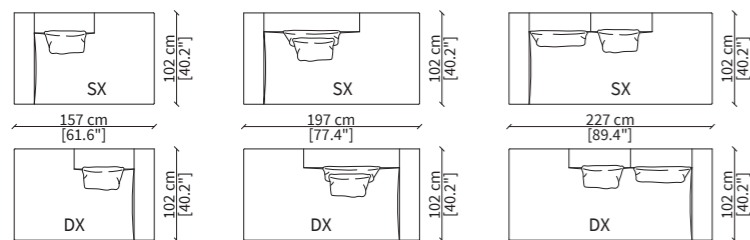

### DORMEUSES PER TOP / DORMEUSES FOR TOP

12915

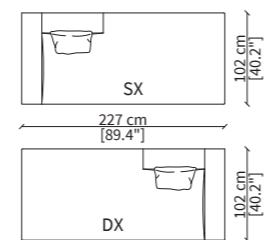

Dimensioni espresse in cm se non diversamente indicato.  
L'Azienda si riserva il diritto di apportare modifiche ai modelli senza preavviso.  
Tolleranza sulle misure indicate di +/- 2%.

Dimensions in centimeter if not differently indicated.  
The Company reserves the right to change the models without any advance notice.  
Tolerance on the given sizes +/- 2%.

## TAYLOR MEDIUM SOFA

Design R&D Frigerio

### CENTRALI DORMEUSE / CENTRAL DORMEUSES

12916 12917 12918

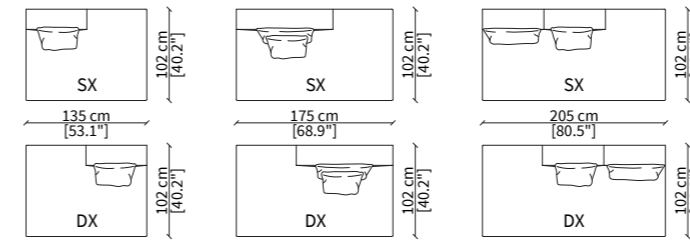

### CENTRALE DORMEUSE PER TOP / CENTRAL DORMEUSE FOR TOP

12919

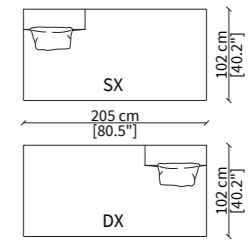

### CHAISES LONGUE

12921 12920

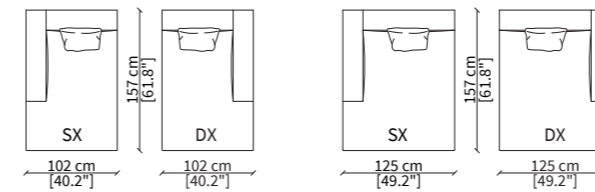

### CHAISE LONGUE CENTRALE / CENTRAL CHAISE LONGUE

12922

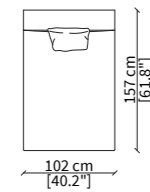

### ELEMENTI LONGUE / LONGUE ELEMENTS

12709 12710 12711

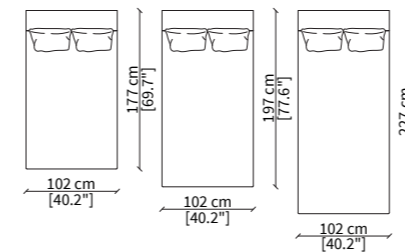

### ELEMENTO ANGOLO / CORNER ELEMENT

12923

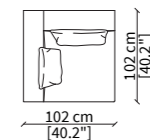

### POUFS

12735 12736 12737

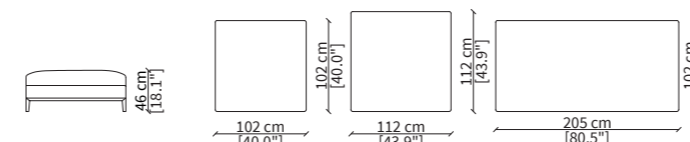

12738 12739 12740

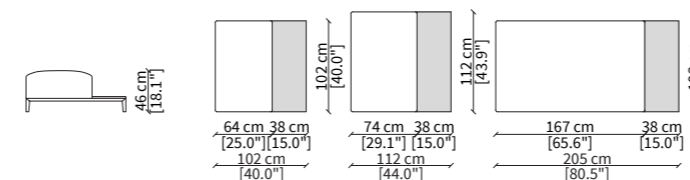

13302 13303 13304

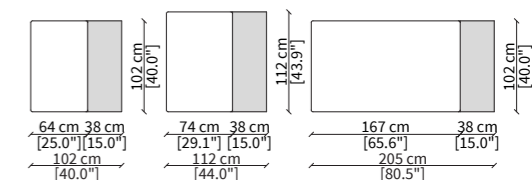

Dimensioni espresse in cm se non diversamente indicato.  
L'Azienda si riserva il diritto di apportare modifiche ai modelli senza preavviso.  
Tolleranza sulle misure indicate di +/- 2%.

Dimensions in centimeter if not differently indicated.  
The Company reserves the right to change the models without any advance notice.  
Tolerance on the given sizes +/- 2%.

## TAYLOR MEDIUM SOFA Design R&D Frigerio

### MENSOLE LATERALI / SIDE SHELVES

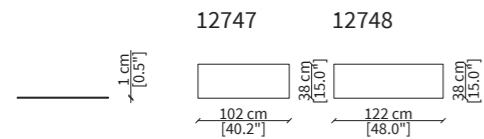

### MENSOLE SCHIENALE / BACK SHELVES

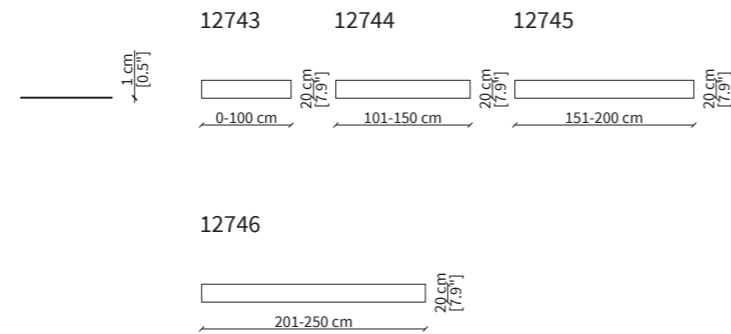

### CABINET

12749M

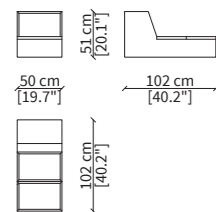

### LAMPADA / LAMP

TYDA

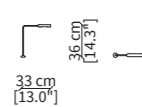

### CUSCINI / CUSHIONS

TP TA



14034 14035

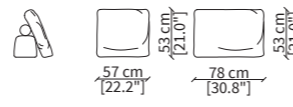

### ESEMPI DI COMPOSIZIONE AD ANGOLO / EXAMPLES OF CORNER COMPOSITIONS

Le composizioni ad angolo possono essere così realizzate:  
Corner composition can be built as follows:

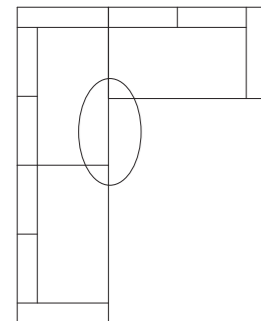

1. accostando tra loro gli elementi. Sugeriamo l'aggiunta di un cuscino schienale per maggior comfort nell'angolo.

1. by combining the elements. We recommend adding an extra back cushion for a better comfort in the corner.

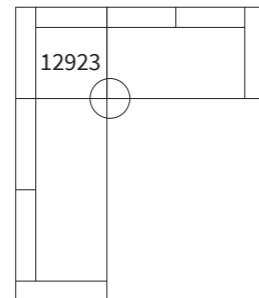

2. utilizzando l'angolo (art. **12923**) per un allineamento preciso delle sedute.

2. by using the corner (art. **12923**) for a perfect alignment of the seats.

### ESEMPI DI COMPOSIZIONE CON MENSOLE / EXAMPLES OF COMPOSITIONS WITH SHELVES

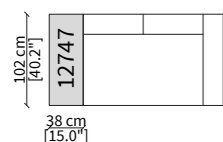

1. mensola laterale (art. **12747**).
1. side shelf (art. **12747**).

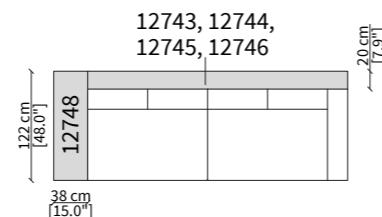

2. mensola laterale (art. **12748**) e mensola schienale.
2. side shelf (art. **12748**) and back shelf.

## TAYLOR MEDIUM SOFA Design R&D Frigerio

### COMPOSIZIONE 1 / COMPOSITION 1

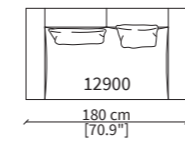

CODICI / CODES: **12900**

### COMPOSIZIONE 2 / COMPOSITION 2

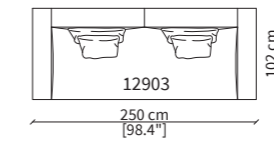

CODICI / CODES: **12903**

### COMPOSIZIONE 3 / COMPOSITION 3

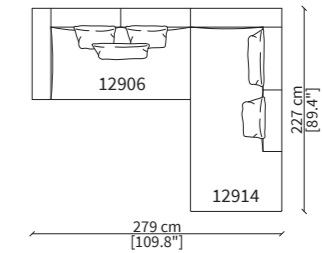

CODICI / CODES: **12906, 12914**

### COMPOSIZIONE 4 / COMPOSITION 4

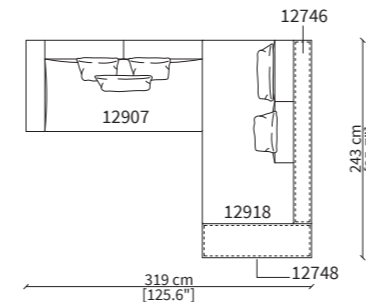

CODICI / CODES: **12907, 12746, 12918, 12748**

### COMPOSIZIONE 5 / COMPOSITION 5

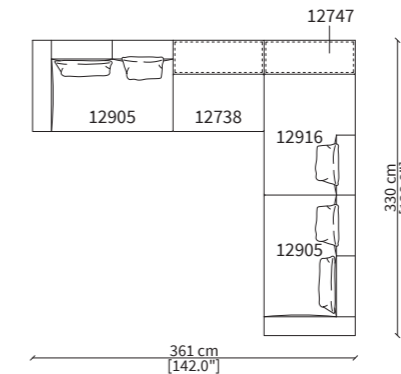

CODICI / CODES: **12905 x 2, 12738, 12747, 12916**

### COMPOSIZIONE 6 / COMPOSITION 6

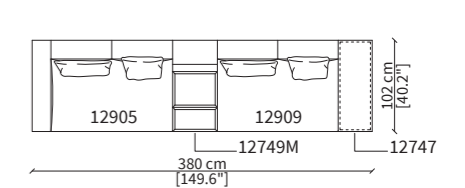

CODICI / CODES: **12905, 12749M, 12909, 12747**

Dimensioni espresse in cm se non diversamente indicato.  
L'Azienda si riserva il diritto di apportare modifiche ai modelli senza preavviso.  
Tolleranza sulle misure indicate di +/- 2%.

Dimensions in centimeter if not differently indicated.  
The Company reserves the right to change the models without any advance notice.  
Tolerance on the given sizes +/- 2%.

## TAYLOR LARGE SOFA

Design R&D Frigerio

### TAYLOR LARGE FIX BACK / d. 112 cm

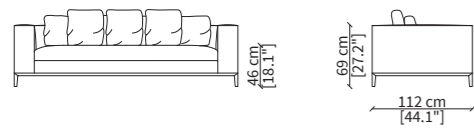

### DIVANI / SOFAS

13000 13001 13002 13003

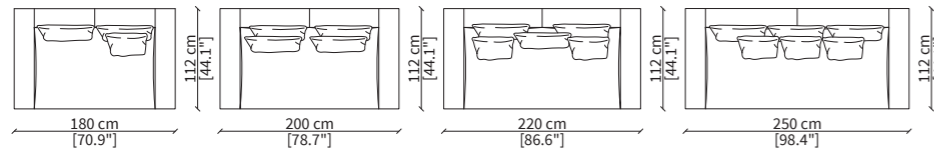

### DIVANO PER TOP / SOFA FOR TOP

13004

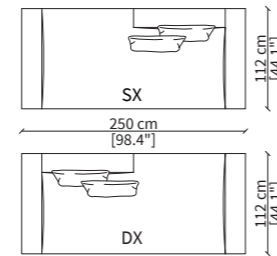

### ELEMENTI TERMINALI / TERMINAL ELEMENTS

13005 13006 13007 13008

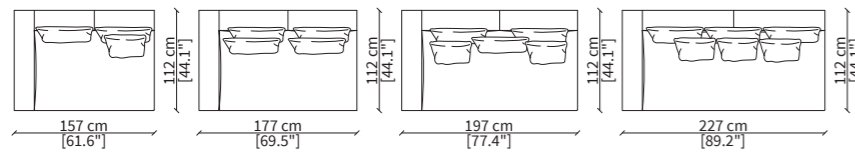

### ELEMENTI CENTRALI / CENTRAL ELEMENTS

13009 13010 13011

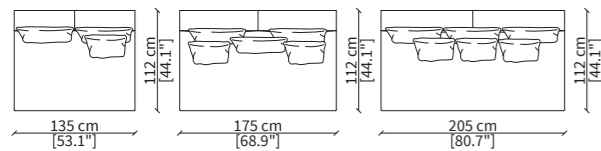

### DORMEUSES

13012 13013 13014

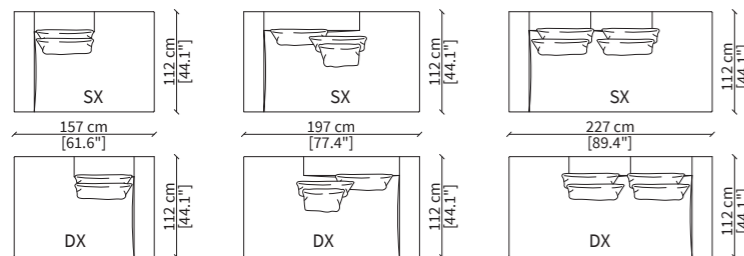

### DORMEUSES PER TOP / DORMEUSES FOR TOP

13015

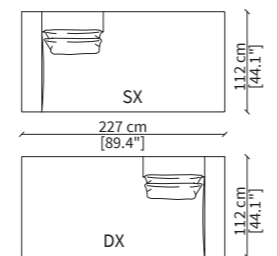

Dimensioni espresse in cm se non diversamente indicato.  
L'Azienda si riserva il diritto di apportare modifiche ai modelli senza preavviso.  
Tolleranza sulle misure indicate di +/- 2%.

Dimensions in centimeter if not differently indicated.  
The Company reserves the right to change the models without any advance notice.  
Tolerance on the given sizes +/- 2%.

## TAYLOR LARGE SOFA

Design R&D Frigerio

### CENTRALI DORMEUSE / CENTRAL DORMEUSES

13016 13017 13018

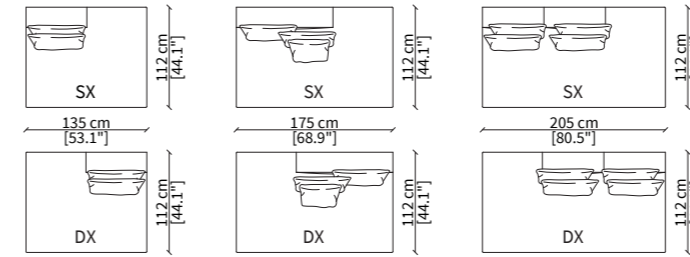

### CENTRALE DORMEUSE PER TOP / CENTRAL DORMEUSE FOR TOP

13019

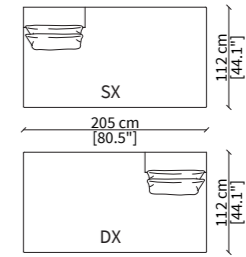

### CHAISES LONGUE

12921 12920

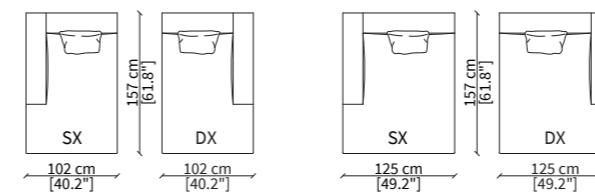

### CHAISE LONGUE CENTRALE / CENTRAL CHAISE LONGUE

12922

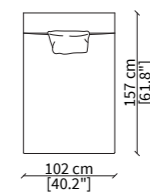

### ELEMENTI LONGUE / LONGUE ELEMENTS

12709 12710 12711

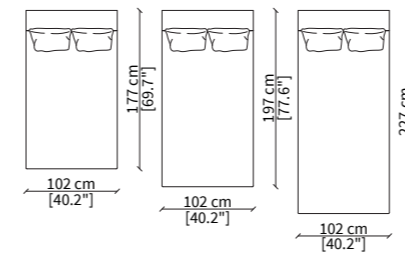

### ELEMENTO ANGOLO / CORNER ELEMENT

13020

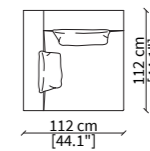

### POUFS

12735 12736 12737

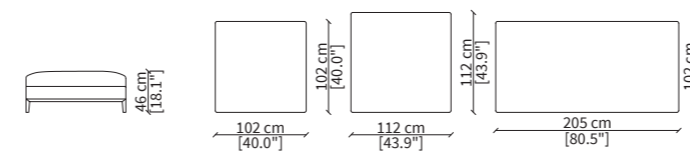

12738 12739 12740

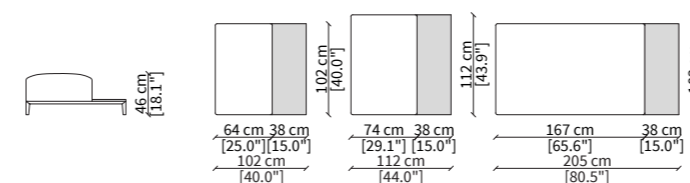

13302 13303 13304

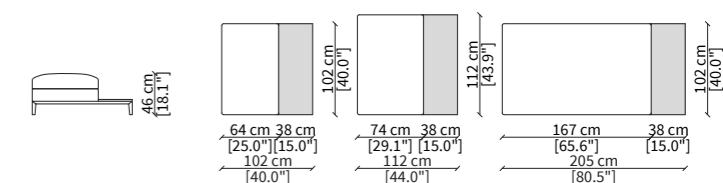

Dimensioni espresse in cm se non diversamente indicato.  
L'Azienda si riserva il diritto di apportare modifiche ai modelli senza preavviso.  
Tolleranza sulle misure indicate di +/- 2%.

Dimensions in centimeter if not differently indicated.  
The Company reserves the right to change the models without any advance notice.  
Tolerance on the given sizes +/- 2%.

## TAYLOR LARGE SOFA Design R&D Frigerio

### MENSOLE LATERALI / SIDE SHELVES

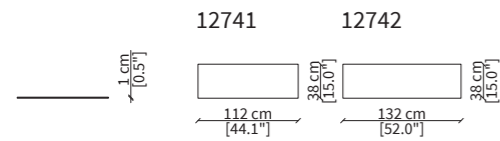

### MENSOLE SCHIENALE / BACK SHELVES

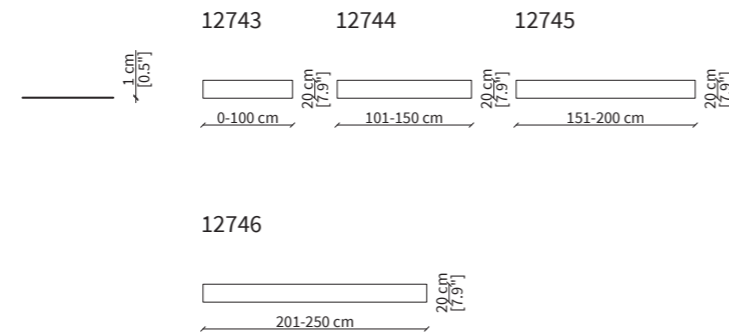

### CABINET

12749L

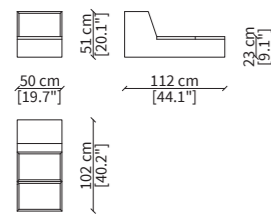

### LAMPADA / LAMP

TYDA

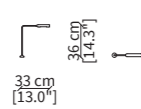

### CUSCINI / CUSHIONS

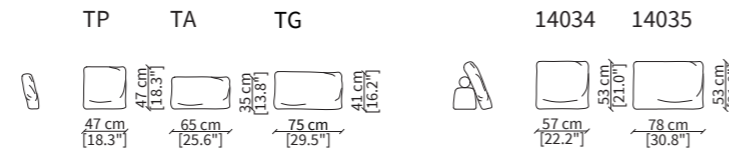

### ESEMPI DI COMPOSIZIONE AD ANGOLO / EXAMPLES OF CORNER COMPOSITIONS

Le composizioni ad angolo possono essere così realizzate:  
Corner composition can be built as follows:

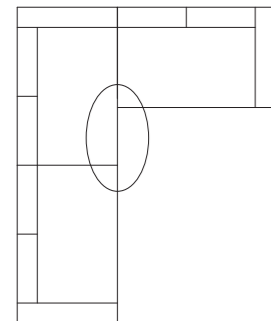

1. accostando tra loro gli elementi. Sugeriamo l'aggiunta di un cuscino schienale per maggior comfort nell'angolo.

1. by combining the elements. We recommend adding an extra back cushion for a better comfort in the corner.

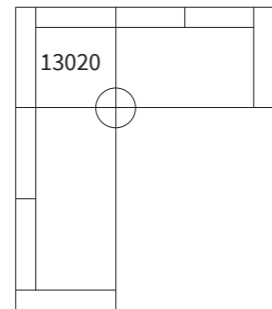

2. utilizzando l'angolo (art. **13020**) per un allineamento preciso delle sedute.

2. by using the corner (art. **13020**) for a perfect alignment of the seats.

### ESEMPI DI COMPOSIZIONE CON MENSOLE / EXAMPLES OF COMPOSITIONS WITH SHELVES

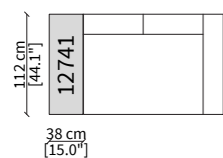

1. mensola laterale (art. **12741**).
1. side shelf (art. **12741**).

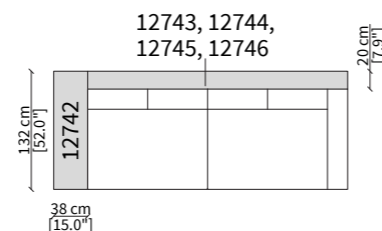

2. mensola laterale (art. **12742**) e mensola schienale.
2. side shelf (art. **12742**) and back shelf.

## TAYLOR LARGE SOFA Design R&D Frigerio

### COMPOSIZIONE 1 / COMPOSITION 1

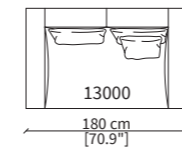

CODICI / CODES: **13000**

### COMPOSIZIONE 2 / COMPOSITION 2

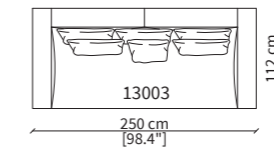

CODICI / CODES: **13003**

### COMPOSIZIONE 3 / COMPOSITION 3

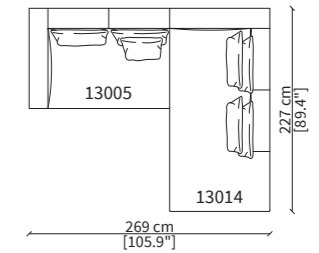

CODICI / CODES: **13005, 13014**

### COMPOSIZIONE 4 / COMPOSITION 4

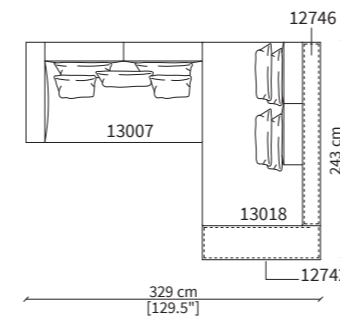

CODICI / CODES: **13007, 13018, 12746, 12742**

### COMPOSIZIONE 5 / COMPOSITION 5

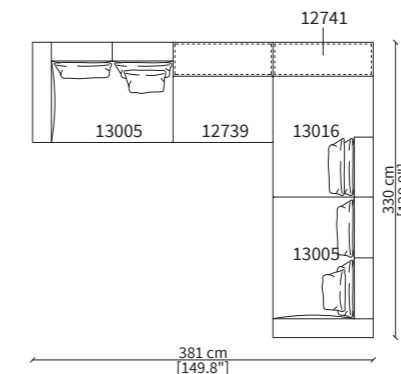

CODICI / CODES: **13005 x 2, 12739, 13016, 12741**

### COMPOSIZIONE 6 / COMPOSITION 6

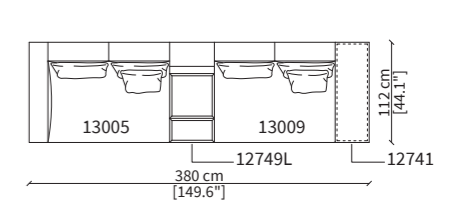

CODICI / CODES: **13005, 12749L, 13009, 12741**

Dimensioni espresse in cm se non diversamente indicato.  
L'Azienda si riserva il diritto di apportare modifiche ai modelli senza preavviso.  
Tolleranza sulle misure indicate di +/- 2%.

Dimensions in centimeter if not differently indicated.  
The Company reserves the right to change the models without any advance notice.  
Tolerance on the given sizes +/- 2%.

## TAYLOR UP MEDIUM SOFA

Design R&D Frigerio

### TAYLOR UP MEDIUM UP BACK / d. 102 - 107 cm

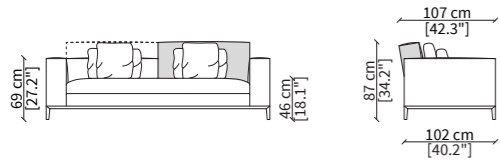

## DIVANI / SOFAS

12700

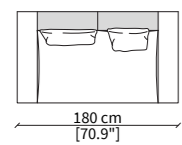

12701

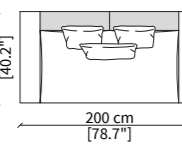

12702

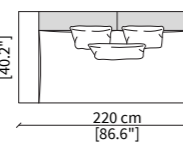

12703

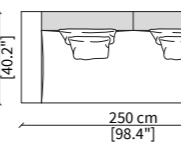

## DIVANO PER TOP / SOFA FOR TOP

12704

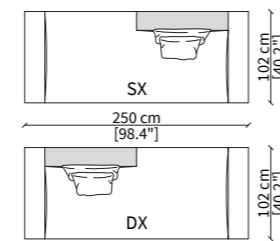

## ELEMENTI TERMINALI / TERMINAL ELEMENTS

12705

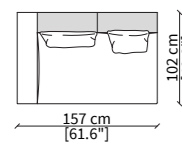

12706

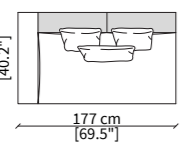

12707

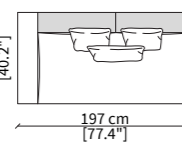

12708

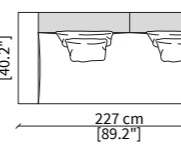

## ELEMENTI CENTRALI / CENTRAL ELEMENTS

12712

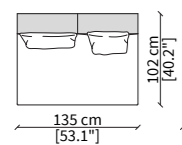

12713

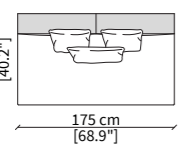

12714

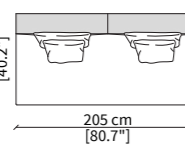

## DORMEUSES

12715

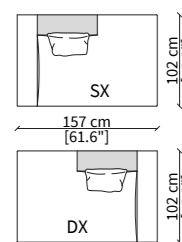

12716

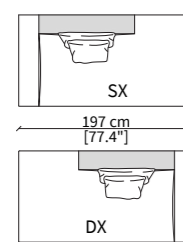

12717

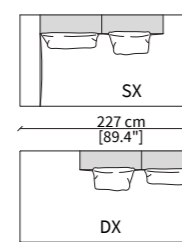

## DORMEUSES PER TOP / DORMEUSES FOR TOP

12718

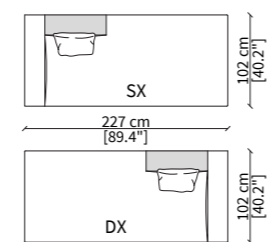

Dimensioni espresse in cm se non diversamente indicato.  
L'Azienda si riserva il diritto di apportare modifiche ai modelli senza preavviso.  
Tolleranza sulle misure indicate di +/- 2%.

Dimensions in centimeter if not differently indicated.  
The Company reserves the right to change the models without any advance notice.  
Tolerance on the given sizes +/- 2%.

## TAYLOR UP MEDIUM SOFA

Design R&D Frigerio

### CENTRALI DORMEUSE / CENTRAL DORMEUSES

12719

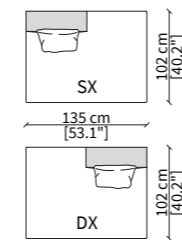

12720

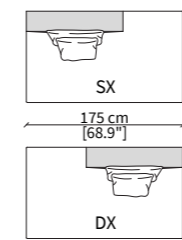

12721

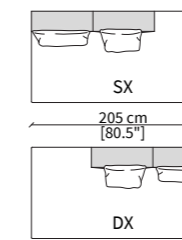

### CENTRALE DORMEUSE PER TOP / CENTRAL DORMEUSE FOR TOP

12722

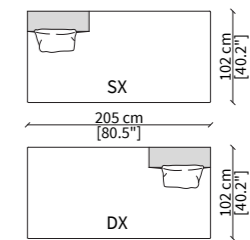

## CHAISES LONGUE

12724

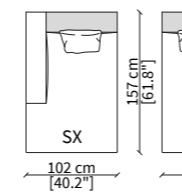

12723

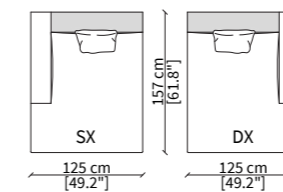

## CHAISE LONGUE CENTRALE / CENTRAL CHAISE LONGUE

12725

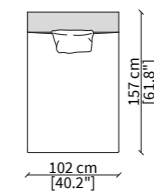

## ELEMENTI LONGUE / LONGUE ELEMENTS

12709

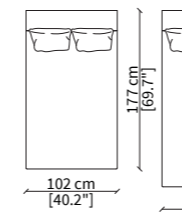

12710

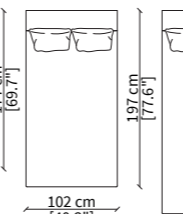

12711

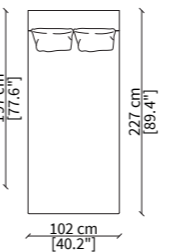

## ELEMENTO ANGOLO / CORNER ELEMENT

12726

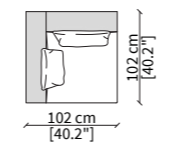

## DIVANO ANGOLO / SOFA CORNER

12727

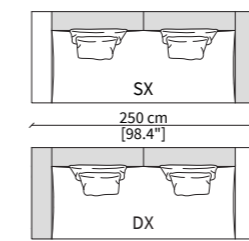

## DIVANO ANGOLO PER TOP / SOFA CORNER FOR TOP

12728

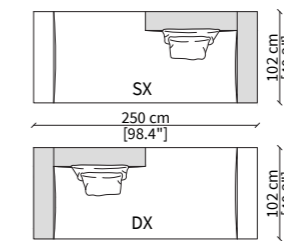

## TERMINALE ANGOLO / TERMINAL CORNER

12729

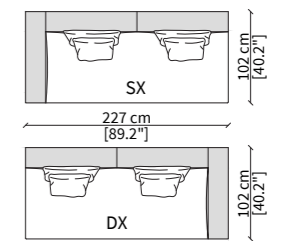

Dimensioni espresse in cm se non diversamente indicato.  
L'Azienda si riserva il diritto di apportare modifiche ai modelli senza preavviso.  
Tolleranza sulle misure indicate di +/- 2%.

Dimensions in centimeter if not differently indicated.  
The Company reserves the right to change the models without any advance notice.  
Tolerance on the given sizes +/- 2%.

## TAYLOR UP MEDIUM SOFA Design R&D Frigerio

### DORMEUSE ANGOLO / DORMEUSE CORNER 12733

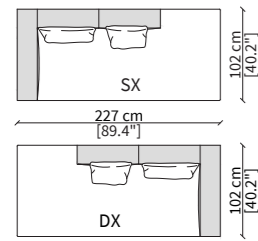

### DORMEUSE ANGOLO PER TOP / DORMEUSE CORNER FOR TOP 12734

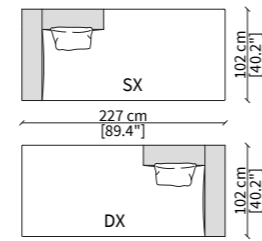

### LONGUES ANGOLO / LONGUES CORNER 12730 12731 12732

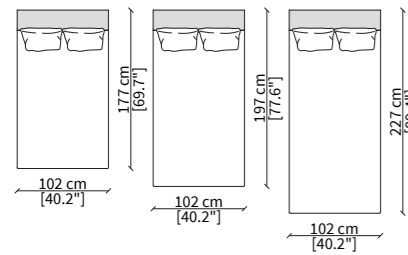

## POUFS

### 12735 12736 12737

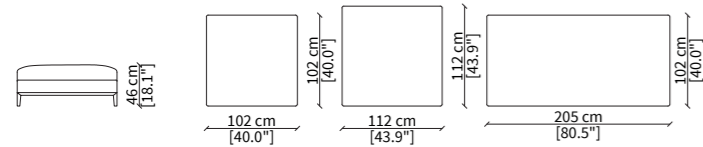

### 12738 12739 12740

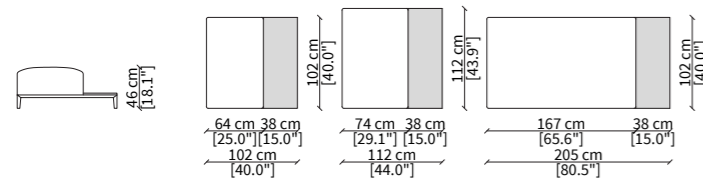

### 13302 13303 13304

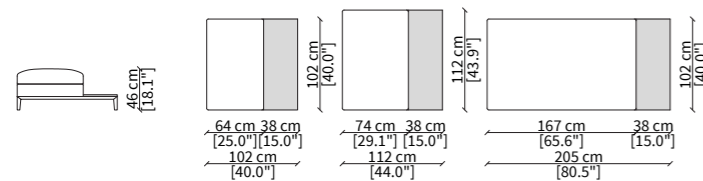

Dimensioni espresse in cm se non diversamente indicato.  
L'Azienda si riserva il diritto di apportare modifiche ai modelli senza preavviso.  
Tolleranza sulle misure indicate di +/- 2%.

Dimensions in centimeter if not differently indicated.  
The Company reserves the right to change the models without any advance notice.  
Tolerance on the given sizes +/- 2%.

## TAYLOR UP MEDIUM SOFA Design R&D Frigerio

### MENSOLE LATERALI / SIDE SHELVES

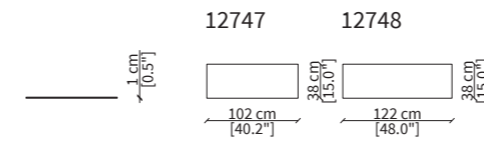

### MENSOLE SCHIENALE / BACK SHELVES

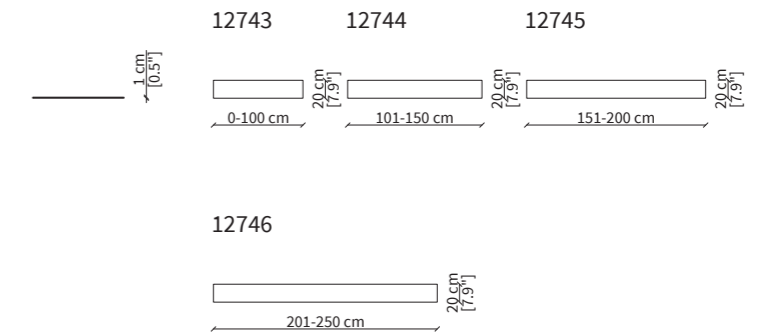

### CABINET

#### 12749M

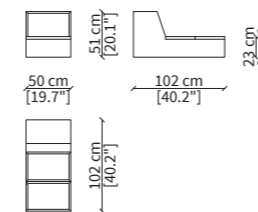

### LAMPADA / LAMP

#### TYDA

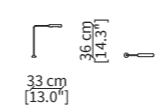

### CUSCINI / CUSHIONS

#### TP TA



#### 14034 14035

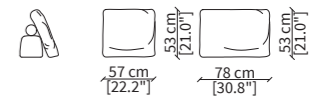

Dimensioni espresse in cm se non diversamente indicato.  
L'Azienda si riserva il diritto di apportare modifiche ai modelli senza preavviso.  
Tolleranza sulle misure indicate di +/- 2%.

Dimensions in centimeter if not differently indicated.  
The Company reserves the right to change the models without any advance notice.  
Tolerance on the given sizes +/- 2%.



## TAYLOR UP MEDIUM SOFA Design R&D Frigerio

### DETTAGLI DEGLI ELEMENTI ANGOLO / DETAILS OF ELEMENTS CORNER

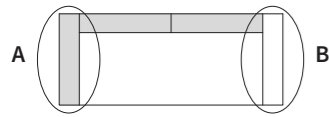

**A** angolo  
corner

**B** bracciolo  
armrest

### ESEMPI DI COMPOSIZIONE AD ANGOLO / EXAMPLES OF CORNER COMPOSITIONS

Le composizioni ad angolo possono essere così realizzate:  
Corner composition can be built as follows:

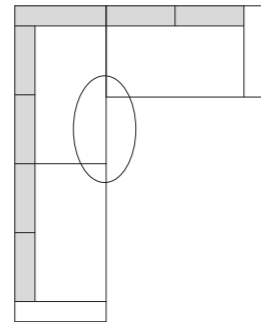

1. utilizzando gli elementi "divano angolo", "terminali angolo", "longues angolo" o "dormeuses angolo".

1. by using the elements "sofa corner", "terminals corner", "longues corner" or "dormeuses corner".

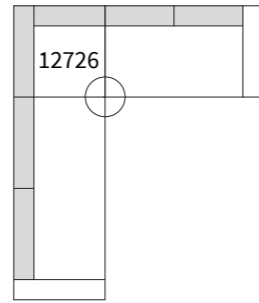

2. utilizzando l'angolo (art. **12726**) per un allineamento preciso delle sedute.

2. by using the corner (art. **12726**) for a perfect alignment of the seats.

### ESEMPI DI COMPOSIZIONE CON MENSOLE / EXAMPLES OF COMPOSITIONS WITH SHELVES

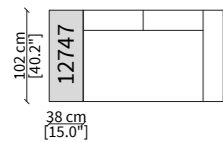

1. mensola laterale (art. **12747**).  
1. side shelf (art. **12747**).

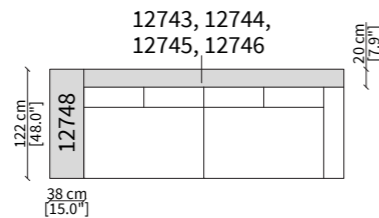

2. mensola laterale (art. **12748**) e mensola schienale.  
2. side shelf (art. **12748**) and back shelf.

## TAYLOR UP MEDIUM SOFA Design R&D Frigerio

### COMPOSIZIONE 1 / COMPOSITION 1

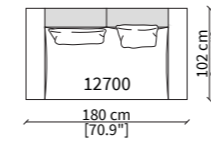

CODICI / CODES: **12700**

### COMPOSIZIONE 2 / COMPOSITION 2

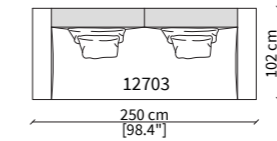

CODICI / CODES: **12703**

### COMPOSIZIONE 3 / COMPOSITION 3

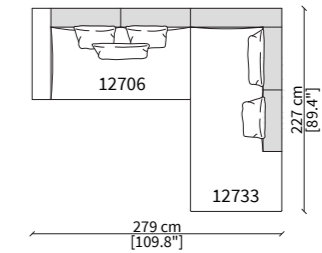

CODICI / CODES: **12706, 12733**

### COMPOSIZIONE 4 / COMPOSITION 4

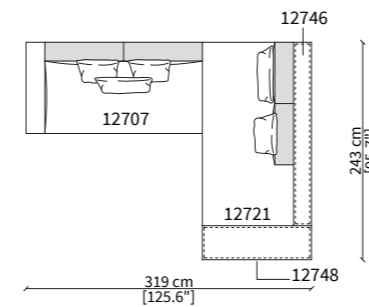

CODICI / CODES: **12707, 12721, 12746, 12748**

### COMPOSIZIONE 5 / COMPOSITION 5

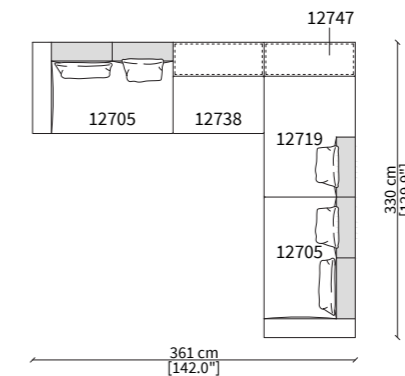

CODICI / CODES: **12705 x 2, 12738, 12719, 12747**

### COMPOSIZIONE 6 / COMPOSITION 6

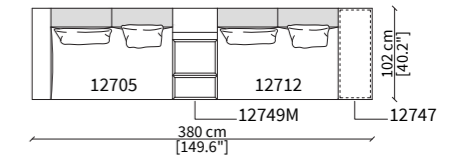

CODICI / CODES: **12705, 12749M, 12712, 12747**



## TAYLOR UP LARGE SOFA

Design R&D Frigerio

### TAYLOR UP LARGE UP BACK / d. 112 - 117 cm

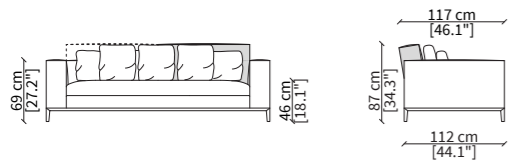

### DIVANI / SOFAS

12800 12801 12802 12803

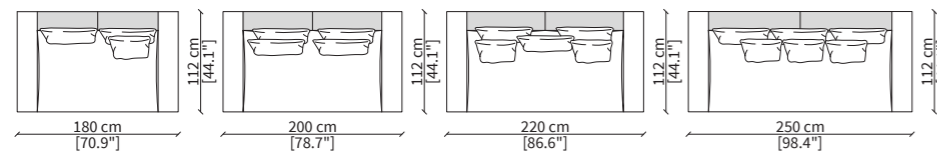

### DIVANO PER TOP / SOFA FOR TOP

13004

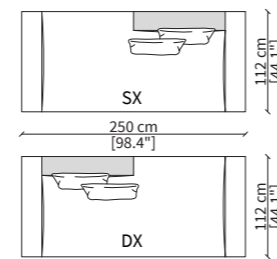

### ELEMENTI TERMINALI / TERMINAL ELEMENTS

12805 12806 12807 12808

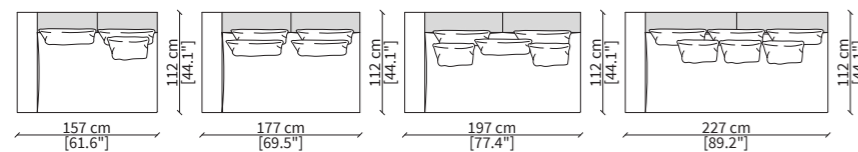

### ELEMENTI CENTRALI / CENTRAL ELEMENTS

12809 12810 12811

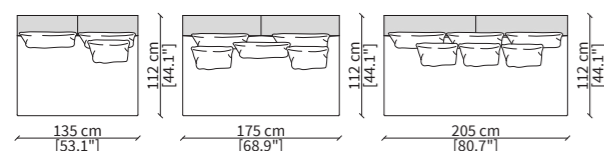

### DORMEUSES

12812 12813 12814

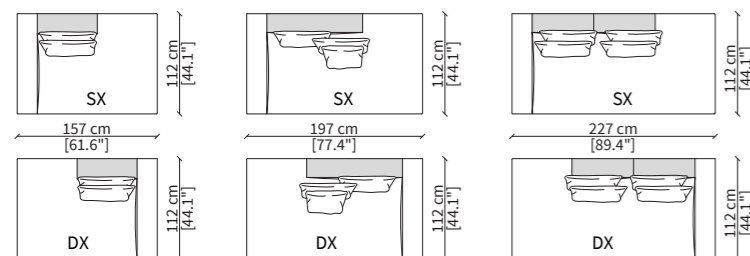

### DORMEUSES PER TOP / DORMEUSES FOR TOP

12815

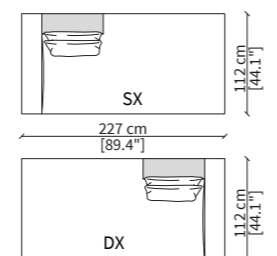

Dimensioni espresse in cm se non diversamente indicato.  
L'Azienda si riserva il diritto di apportare modifiche ai modelli senza preavviso.  
Tolleranza sulle misure indicate di +/- 2%.

Dimensions in centimeter if not differently indicated.  
The Company reserves the right to change the models without any advance notice.  
Tolerance on the given sizes +/- 2%.

## TAYLOR UP LARGE SOFA

Design R&D Frigerio

### CENTRALI DORMEUSE / CENTRAL DORMEUSES

12816 12817 12818

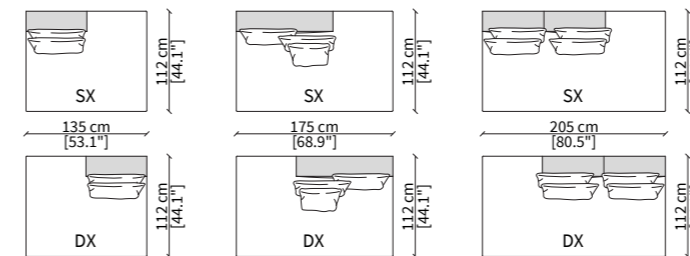

### CENTRALE DORMEUSE PER TOP / CENTRAL DORMEUSE FOR TOP

12819

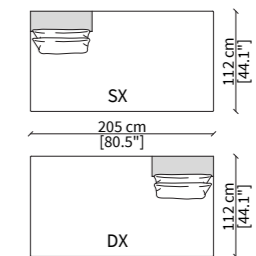

### CHAISES LONGUE

12724 12723

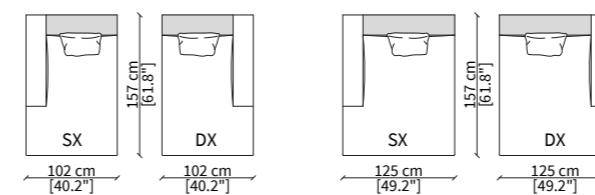

### CHAISE LONGUE CENTRALE / CENTRAL CHAISE LONGUE

12725

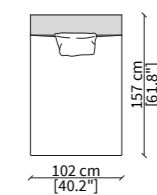

### ELEMENTI LONGUE / LONGUE ELEMENTS

12709 12710 12711

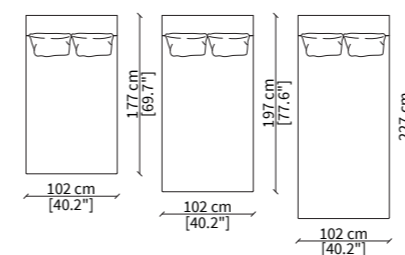

### ELEMENTO ANGOLO / CORNER ELEMENT

12820

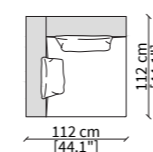

### DIVANO ANGOLO / SOFA CORNER

12821

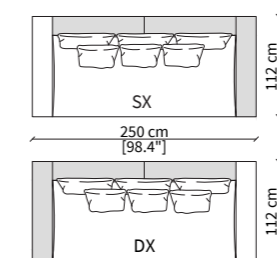

### TERMINALE ANGOLO / TERMINAL CORNER

12822

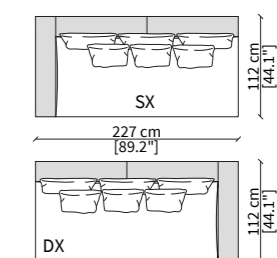

Dimensioni espresse in cm se non diversamente indicato.  
L'Azienda si riserva il diritto di apportare modifiche ai modelli senza preavviso.  
Tolleranza sulle misure indicate di +/- 2%.

Dimensions in centimeter if not differently indicated.  
The Company reserves the right to change the models without any advance notice.  
Tolerance on the given sizes +/- 2%.

## TAYLOR UP LARGE SOFA Design R&D Frigerio

### DORMEUSE ANGOLO / DORMEUSE CORNER 12823

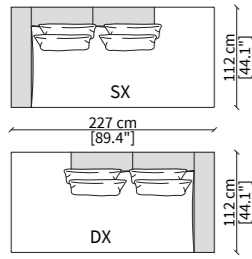

### DORMEUSE ANGOLO PER TOP / DORMEUSE CORNER FOR TOP 12824

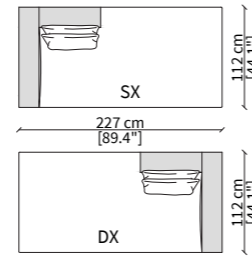

### LONGUES ANGOLO / LONGUES CORNER 12730 12731 12732

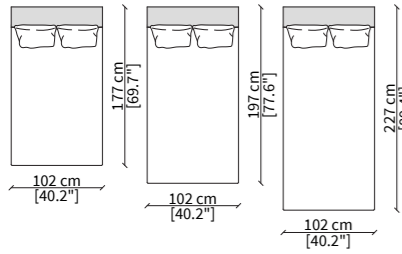

## POUFS

### 12735 12736 12737

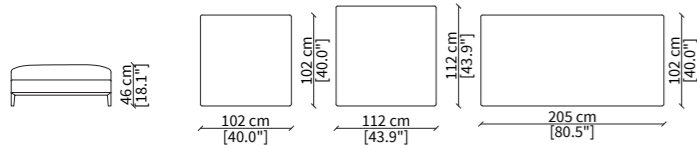

### 12738 12739 12740

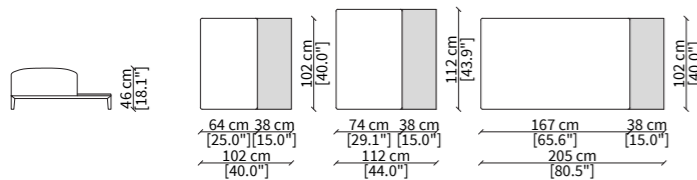

### 13302 13303 13304

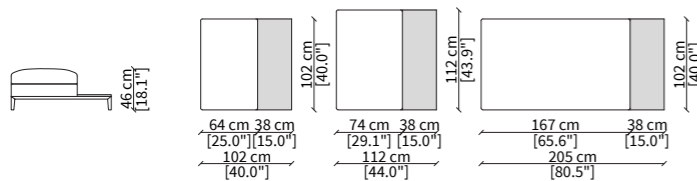

Dimensioni espresse in cm se non diversamente indicato.  
L'Azienda si riserva il diritto di apportare modifiche ai modelli senza preavviso.  
Tolleranza sulle misure indicate di +/- 2%.

Dimensions in centimeter if not differently indicated.  
The Company reserves the right to change the models without any advance notice.  
Tolerance on the given sizes +/- 2%.

## TAYLOR UP LARGE SOFA Design R&D Frigerio

### MENSOLE LATERALI / SIDE SHELVES

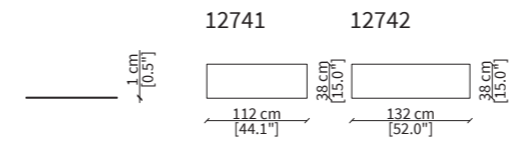

### MENSOLE SCHIENALE / BACK SHELVES

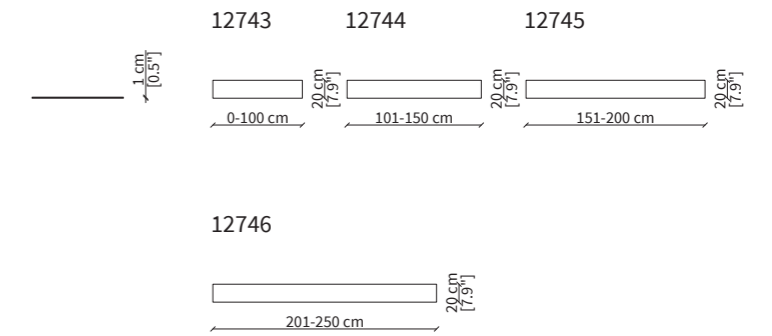

### CABINET

#### 12749L

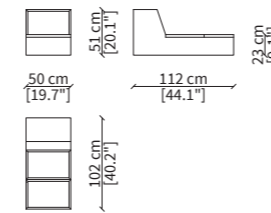

### LAMPADA / LAMP

#### TYDA

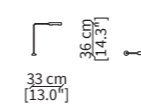

### CUSCINI / CUSHIONS

#### TP TA TG



#### 14034 14035

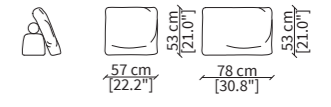

Dimensioni espresse in cm se non diversamente indicato.  
L'Azienda si riserva il diritto di apportare modifiche ai modelli senza preavviso.  
Tolleranza sulle misure indicate di +/- 2%.

Dimensions in centimeter if not differently indicated.  
The Company reserves the right to change the models without any advance notice.  
Tolerance on the given sizes +/- 2%.

## TAYLOR UP LARGE SOFA Design R&D Frigerio

### DETTAGLI DEGLI ELEMENTI ANGOLO / DETAILS OF ELEMENTS CORNER

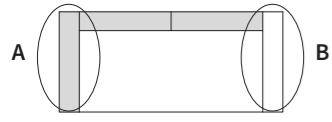

**A** angolo (rialzabile)  
corner (raisable)

**B** bracciolo (non rialzabile)  
armrest (not raisable)

### ESEMPI DI COMPOSIZIONE AD ANGOLO / EXAMPLES OF CORNER COMPOSITIONS

Le composizioni ad angolo possono essere così realizzate:  
Corner composition can be built as follows:

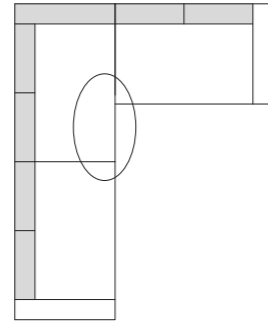

1. utilizzando gli elementi "divano angolo", "terminali angolo", "longues angolo" o "dormeuses angolo".

1. by using the elements "sofa corner", "terminals corner", "longues corner" or "dormeuses corner".

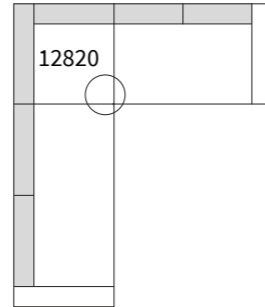

2. utilizzando l'angolo (art. **12820**) per un allineamento preciso delle sedute.

2. by using the corner (art. **12820**) for a perfect alignment of the seats.

### ESEMPI DI COMPOSIZIONE CON MENSOLE / EXAMPLES OF COMPOSITIONS WITH SHELVES

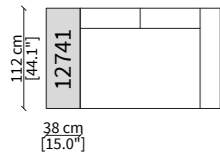

1. mensola laterale (art. **12741**).  
1. side shelf (art. **12741**).

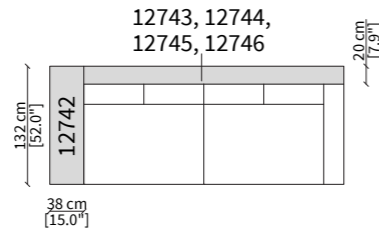

2. mensola laterale (art. **12742**) e mensola schienale.  
2. side shelf (art. **12742**) and back shelf.

## TAYLOR UP LARGE SOFA Design R&D Frigerio

### COMPOSIZIONE 1 / COMPOSITION 1

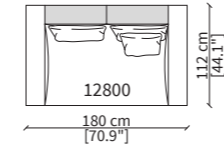

CODICI / CODES: **12700**

### COMPOSIZIONE 2 / COMPOSITION 2

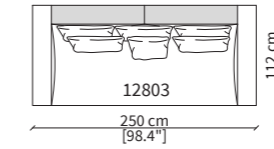

CODICI / CODES: **12703**

### COMPOSIZIONE 3 / COMPOSITION 3

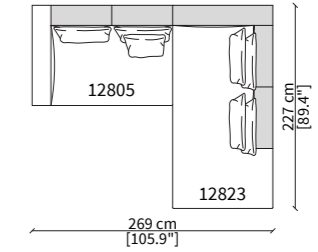

CODICI / CODES: **12706, 12733**

### COMPOSIZIONE 4 / COMPOSITION 4

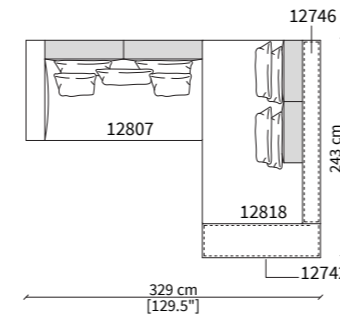

CODICI / CODES: **12707, 12721, 12746, 12748**

### COMPOSIZIONE 5 / COMPOSITION 5

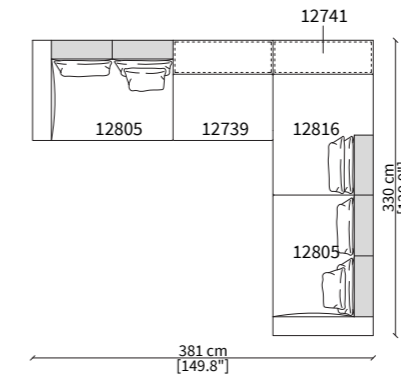

CODICI / CODES: **12705 x 2, 12738, 12719, 12747**

### COMPOSIZIONE 6 / COMPOSITION 6

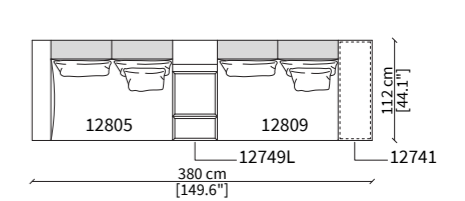

CODICI / CODES: **12705, 12749M, 12712, 12747**

## TAYLOR JUNIOR SOFA

Design R&D Frigerio

TAYLOR JUNIOR - POLTRONA / ARMCHAIR / d. 83 cm

13300

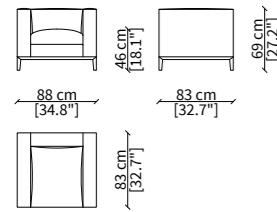

TAYLOR JUNIOR - DIVANETTO / SMALL SOFA / d. 83 cm

13301

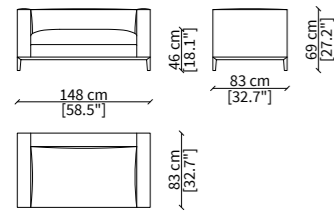

Dimensioni espresse in cm se non diversamente indicato.  
L'Azienda si riserva il diritto di apportare modifiche ai modelli senza preavviso.  
Tolleranza sulle misure indicate di +/- 2%.

Dimensions in centimeter if not differently indicated.  
The Company reserves the right to change the models without any advance notice.  
Tolerance on the given sizes +/- 2%.

Per la gamma completa di materiali è possibile consultare il nostro sito web [www.frigerio.com](http://www.frigerio.com)  
The full range of materials can be found on our website at [www.frigerio.com](http://www.frigerio.com).

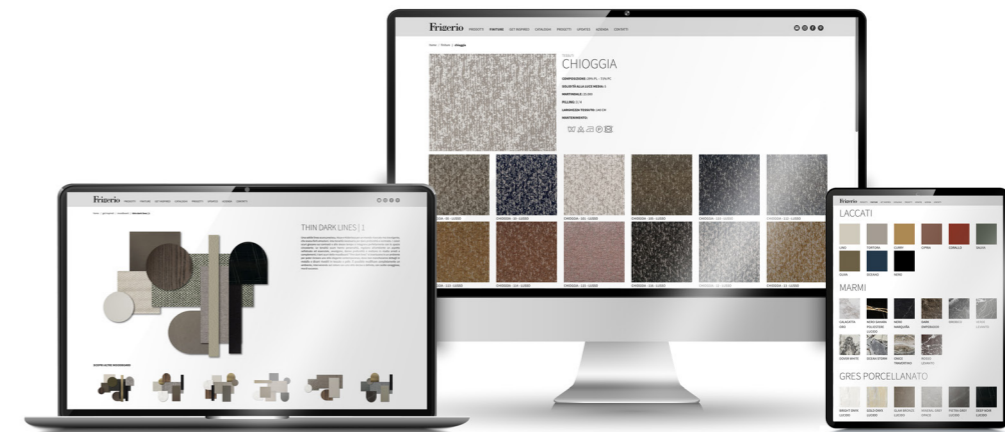

[WWW.FRIGERIO.COM](http://WWW.FRIGERIO.COM)

# Frigerio

Via Sant'Agata 63  
22066 Mariano Comense (CO) - Italy  
Tel. +39 031 5481225  
[info@frigerio.com](mailto:info@frigerio.com)  
[www.frigerio.com](http://www.frigerio.com)