

Frigerio

ORESTE SOFA

Design R&D Department

Uno stile misurato e discreto caratterizza la collezione di divani fissi e modulari Oreste che fa della rigorosa sobrietà il suo punto di forza. Versatile nell'estetica e nell'uso, il divano modulare Oreste dalle proporzioni di divano classico, spazia da un'identità più classica ad una più disinvolta e contemporanea grazie alla possibilità di scegliere tra tre diverse profondità: 88cm, 98cm e 118 cm. Informale nello spirito e avvolgente nei volumi generosi il divano Oreste offre un'ampia modularità con divani chiusi a due e tre posti e modulari con elementi centrali, terminali, ad angolo, dormeuse, chaise-longue, pouf. I rivestimenti sono in tessuto sfoderabile o fissi in pelle. Discreti i piedini in legno massello per un divano classico senza tempo.

A serene and discreet style features the collection of sofas Oreste, which makes the rigorous composure its strong attribute. Versatile in the aesthetic and use, the modular sofa Oreste with classical proportions, ranges from a more classical identity to a more casual and contemporary one thanks to the possibility to select three different depths: 88cm, 98cm and 118cm. Informal in the spirit and enveloping in its generous volumes the sofa Oreste offers a wide range of modularity with two- and three-seater sofas and sectional elements such as central, terminal, corner, dormeuse, chaise longue and poufs. The cover is removable in fabric or fixed in leather. Subtle the legs in solid wood for a classical sofa with timeless look.

Struttura: legno multistrato imbottito in poliuretano espanso indeformabile rivestito in tessuto protettivo accoppiato.

Cuscini seduta: poliuretano espanso indeformabile.

Cuscini schienale: piuma d'oca (Assopiuma).

Piedini: legno color Wengé.

Rivestimento: sfoderabile in tessuto, fisso in pelle.

VERSIONE ORESTE MEDIUM: profondità 98 cm.

VERSIONE ORESTE LARGE: profondità 118 cm.

Structure: plywood padded with non-deformable polyurethane foam covered with doubled protective fabric.

Seat cushions: non-deformable polyurethane foam.

Back cushions: goose down (Assopiuma).

Feet: wood Wenge colour.

Cover: removable in fabric, fix in leather.

VERSION ORESTE MEDIUM: depth 98 cm.

VERSION ORESTE LARGE: depth 118 cm.



ORESTE MEDIUM SOFA

Design R&D Department

ORESTE MEDIUM / d. 98 cm

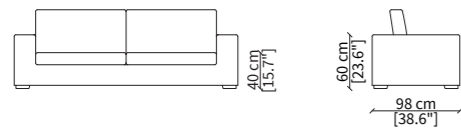

DIVANI / SOFAS

6701 6702 6703 6704

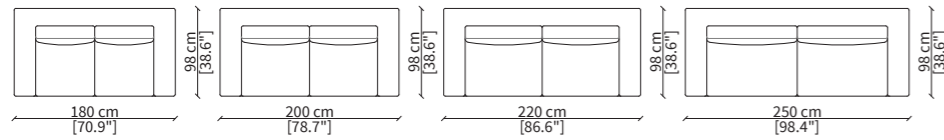

ELEMENTI TERMINALI / TERMINAL ELEMENTS

6705 6706 6707 6708 6709

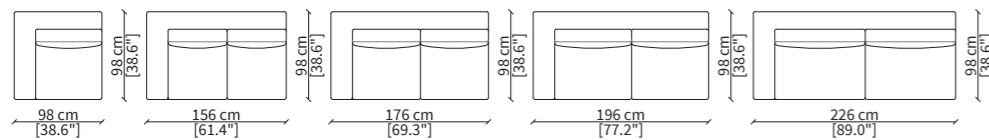

ELEMENTO CENTRALE / CENTRAL ELEMENT

6715

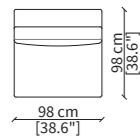

ELEMENTI DORMEUSE / DORMEUSE ELEMENTS

6710 6711 6712

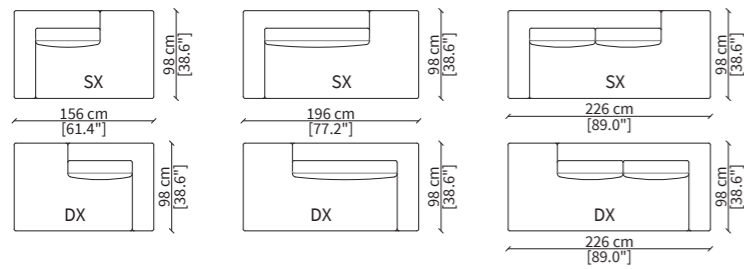

Dimensioni espresse in cm se non diversamente indicato.
L'Azienda si riserva il diritto di apportare modifiche ai modelli senza preavviso.
Tolleranza sulle misure indicate di +/- 2%.

Dimensions in centimeter if not differently indicated.
The Company reserves the right to change the models without any advance notice.
Tolerance on the given sizes +/- 2%.

ORESTE MEDIUM SOFA

Design R&D Department

CHAISE LONGUE

6713

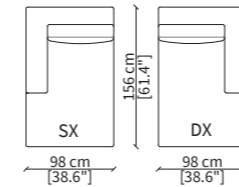

ELEMENTO ANGOLO / CORNER ELEMENT

6714

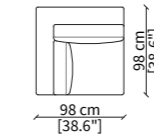

POUFS

6815 6816 6817 6818 6819

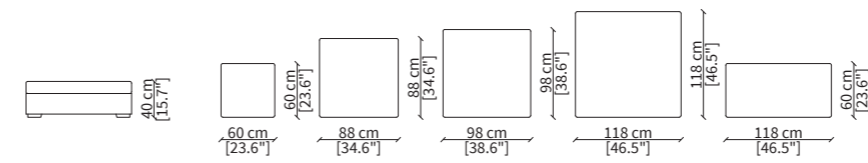

CUSCINI / CUSHIONS

PO SOM
CUSCINO SCHIENALE
BACK CUSHION



7441 7442

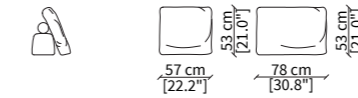

Dimensioni espresse in cm se non diversamente indicato.
L'Azienda si riserva il diritto di apportare modifiche ai modelli senza preavviso.
Tolleranza sulle misure indicate di +/- 2%.

Dimensions in centimeter if not differently indicated.
The Company reserves the right to change the models without any advance notice.
Tolerance on the given sizes +/- 2%.

ORESTE MEDIUM SOFA Design R&D Department

ESEMPI DI COMPOSIZIONE AD ANGOLO / EXAMPLES OF CORNER COMPOSITIONS

Le composizioni ad angolo possono essere così realizzate:
Corner composition can be built as follows:

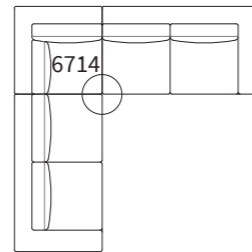
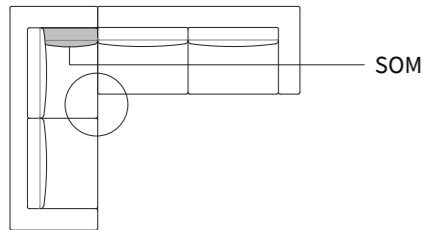

1. accostando tra loro gli elementi, aggiungendo il cuscino schienale **SOM** per dare continuità ai cuscini schienale, se necessario.

2. utilizzando l'angolo (art. **6714**) per un allineamento preciso delle sedute.

1. by combining the elements, adding the **SOM** back cushion to give continuity to the back cushions, if necessary.

2. by using the corner (art. **6714**) for a perfect alignment of the seats.

COMPOSIZIONE DI ELEMENTI MEDIUM CON ELEMENTI LARGE / COMPOSITION OF MEDIUM ELEMENTS WITH LARGE ELEMENTS

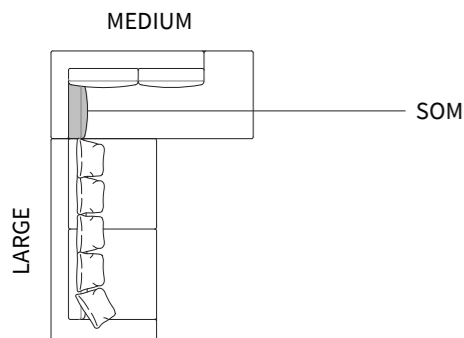

Nel caso in cui vengano accostati tra loro elementi Medium e Large aggiungere sull'elemento Medium, se necessario, il cuscino schienale **SOM** per dare continuità ai cuscini schienale.

In case Medium elements are combined with Large elements, add the **SOM** back cushion to the Medium element, if necessary, to give continuity to the back cushions.

Dimensioni espresse in cm se non diversamente indicato.
L'Azienda si riserva il diritto di apportare modifiche ai modelli senza preavviso.
Tolleranza sulle misure indicate di +/- 2%.

Dimensions in centimeter if not differently indicated.
The Company reserves the right to change the models without any advance notice.
Tolerance on the given sizes +/- 2%.

ORESTE MEDIUM SOFA Design R&D Department

COMPOSIZIONE 1 / COMPOSITION 1

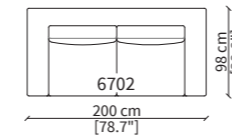

CODICI / CODES: **6702**

COMPOSIZIONE 2 / COMPOSITION 2

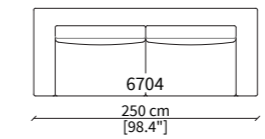

CODICI / CODES: **6704**

COMPOSIZIONE 3 / COMPOSITION 3

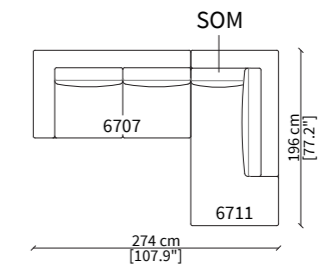

CODICI / CODES: **6707, 6711, SOM**

COMPOSIZIONE 4 / COMPOSITION 4

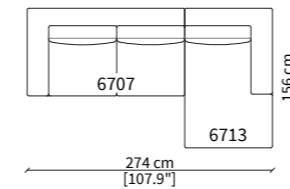

CODICI / CODES: **6707, 6713**

COMPOSIZIONE 5 / COMPOSITION 5

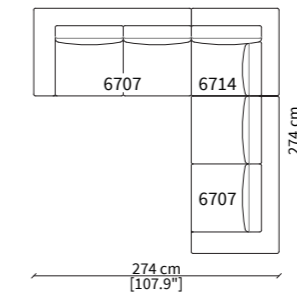

CODICI / CODES: **6707 x 2, 6714**

Dimensioni espresse in cm se non diversamente indicato.
L'Azienda si riserva il diritto di apportare modifiche ai modelli senza preavviso.
Tolleranza sulle misure indicate di +/- 2%.

Dimensions in centimeter if not differently indicated.
The Company reserves the right to change the models without any advance notice.
Tolerance on the given sizes +/- 2%.

ORESTE LARGE SOFA

Design R&D Department

ORESTE LARGE / d. 118 cm

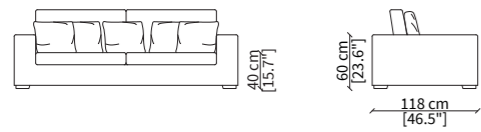

DIVANI / SOFAS

6801 6802 6803 6804

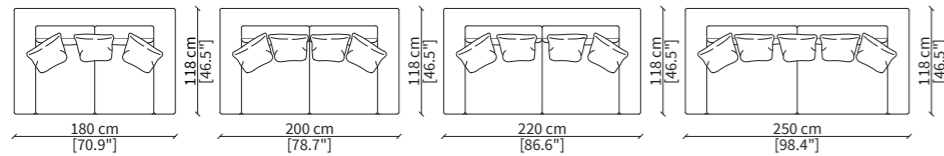

ELEMENTI TERMINALI / TERMINAL ELEMENTS

6805 6806 6807 6808 6809

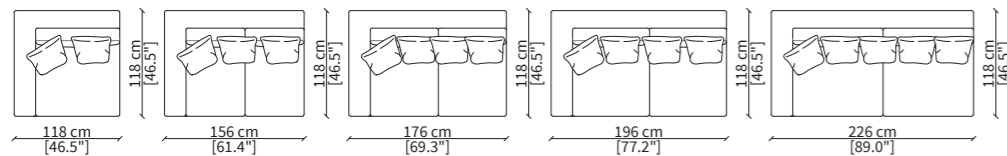

ELEMENTO CENTRALE / CENTRAL ELEMENT

6820

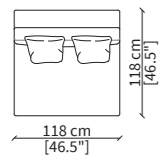

ELEMENTI DORMEUSE / DORMEUSE ELEMENTS

6810 6811 6812

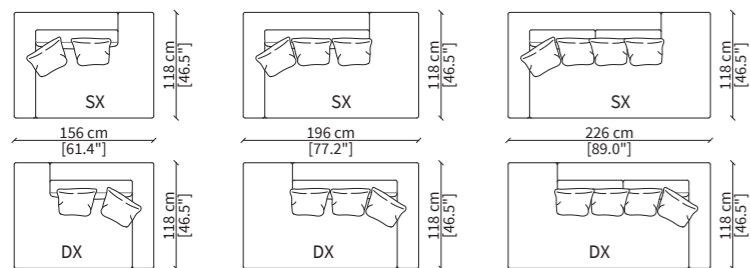

Dimensioni espresse in cm se non diversamente indicato.
L'Azienda si riserva il diritto di apportare modifiche ai modelli senza preavviso.
Tolleranza sulle misure indicate di +/- 2%.

Dimensions in centimeter if not differently indicated.
The Company reserves the right to change the models without any advance notice.
Tolerance on the given sizes +/- 2%.

ORESTE LARGE SOFA

Design R&D Department

CHAISE LONGUE

6813

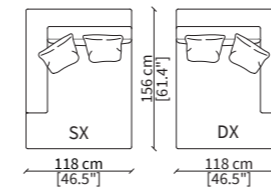

ELEMENTO ANGOLO / CORNER ELEMENT

6814

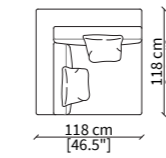

POUFS

6815 6816 6817 6818 6819

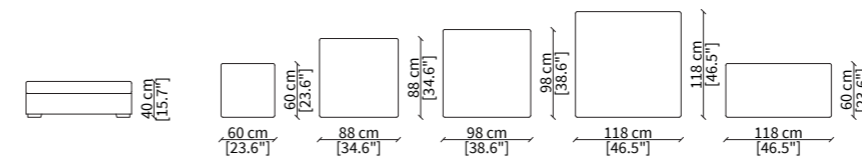

CUSCINI / CUSHIONS

PO



SOL

CUSCINO SCHIENALE
BACK CUSHION

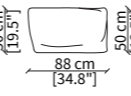

7441

7442

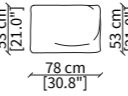

Dimensioni espresse in cm se non diversamente indicato.
L'Azienda si riserva il diritto di apportare modifiche ai modelli senza preavviso.
Tolleranza sulle misure indicate di +/- 2%.

Dimensions in centimeter if not differently indicated.
The Company reserves the right to change the models without any advance notice.
Tolerance on the given sizes +/- 2%.

ORESTE LARGE SOFA Design R&D Department

ESEMPI DI COMPOSIZIONE AD ANGOLO / EXAMPLES OF CORNER COMPOSITIONS

Le composizioni ad angolo possono essere così realizzate:
Corner composition can be built as follows:

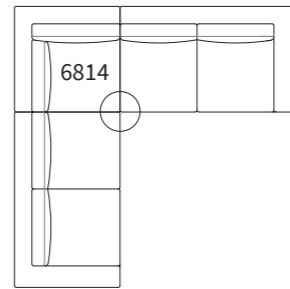
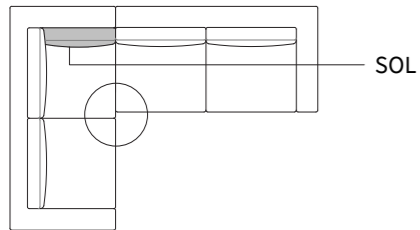

1. accostando tra loro gli elementi, aggiungendo il cuscino schienale **SOL** per dare continuità ai cuscini schienale. Suggeriamo l'aggiunta di un cuscino **PO** per maggior comfort nell'angolo.

2. utilizzando l'angolo (art. **6814**) per un allineamento preciso delle sedute.

1. by combining the elements, adding the **SOL** back cushion to give continuity to the back cushions. We recommend adding an extra **PO** cushion for a better comfort in the corner.

2. by using the corner (art. **6814**) for a perfect alignment of the seats.

COMPOSIZIONE DI ELEMENTI LARGE CON ELEMENTI MEDIUM / COMPOSITION OF LARGE ELEMENTS WITH MEDIUM ELEMENTS

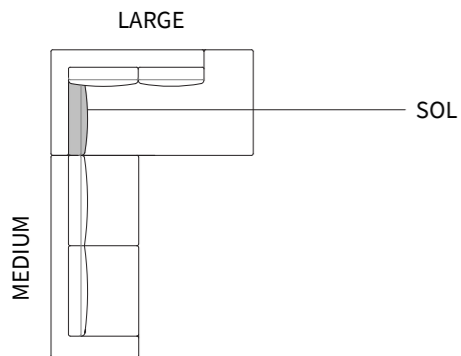

Nel caso in cui vengano accostati tra loro elementi Large e Medium aggiungere sull'elemento Large, se necessario, il cuscino schienale **SOL** per dare continuità ai cuscini schienale.

In case Large elements are combined with Medium elements, add the **SOL** back cushion to the Large element, if necessary, to give continuity to the back cushions.

*Dimensioni espresse in cm se non diversamente indicato.
L'Azienda si riserva il diritto di apportare modifiche ai modelli senza preavviso.
Tolleranza sulle misure indicate di +/- 2%.*

*Dimensions in centimeter if not differently indicated.
The Company reserves the right to change the models without any advance notice.
Tolerance on the given sizes +/- 2%.*

ORESTE LARGE SOFA Design R&D Department

COMPOSIZIONE 1 / COMPOSITION 1

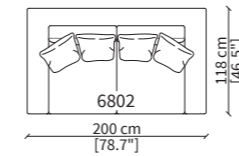

CODICI / CODES: **6802**

COMPOSIZIONE 2 / COMPOSITION 2

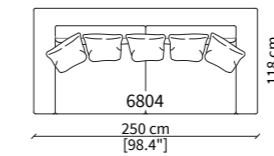

CODICI / CODES: **6804**

COMPOSIZIONE 3 / COMPOSITION 3

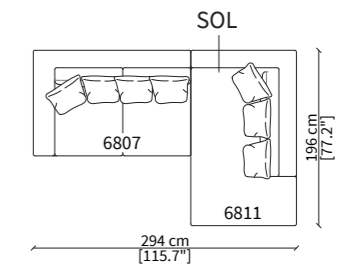

CODICI / CODES: **6807, 6811, SOL**

COMPOSIZIONE 4 / COMPOSITION 4

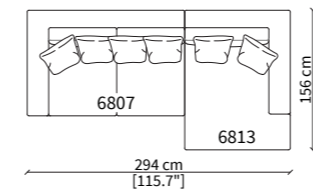

CODICI / CODES: **6807, 6813**

COMPOSIZIONE 5 / COMPOSITION 5

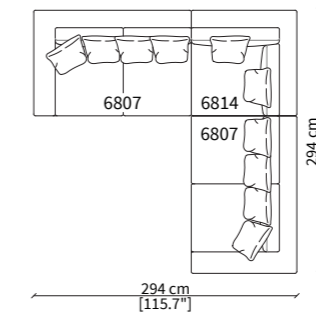

CODICI / CODES: **6807 x 2, 6814**

*Dimensioni espresse in cm se non diversamente indicato.
L'Azienda si riserva il diritto di apportare modifiche ai modelli senza preavviso.
Tolleranza sulle misure indicate di +/- 2%.*

*Dimensions in centimeter if not differently indicated.
The Company reserves the right to change the models without any advance notice.
Tolerance on the given sizes +/- 2%.*

Per la gamma completa di materiali è possibile consultare il nostro sito web www.frigerio.com
The full range of materials can be found on our website at www.frigerio.com.

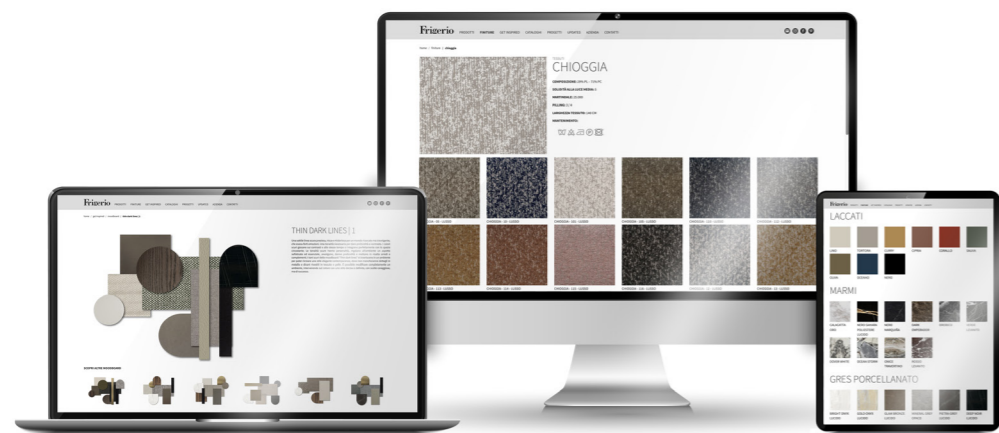

WWW.FRIGERIO.COM

Frigerio

Via Sant'Agata 63
22066 Mariano Comense (CO) - Italy
Tel. +39 031 5481225
info@frigerio.com
www.frigerio.com