

# Frigerio

## MILLER SOFA

Design R&D Frigerio

Estremamente dinamico nell'estetica e nelle funzioni, il divano modulare moderno Miller è concepito come spazio d'incontro. Divani fissi a due e tre posti e modulari con elementi centrali, terminali, angolari, chaise longue, dormeuse, pouf per una proposta estremamente variegata caratterizzata dallo sviluppo marcatamente orizzontale e dai volumi generosi che abbinano superfici lisce a superfici finemente trapuntate. I moduli del divano contemporaneo Miller si possono mixare liberamente creando soluzioni fortemente personalizzate capaci di ribaltare, arricchendola, la funzione classica del divano all'interno degli spazi siano essi domestici o contract. Più che una collezione di sedute, Miller è infatti un vero e proprio sistema d'arredo che ai molteplici moduli imbottiti - disponibili in un'unica profondità ma con diverse tipologie di struttura, braccioli e schienali - unisce contenitori aperti e chiusi o librerie in diversi materiali. Le tre tipologie di bracciolo definiscono la relazione tra le sedute e i volumi integrati: bracciolo standard, Open con complementi posizionati a terra e Top con complementi posizionati sulla base del divano.

Disponibile anche nella versione Miller Double.

Extremely dynamics in the aesthetic and functions, the modern modular sofa Miller is conceived as a space for encounter. Two- and three-seater sofas and sectional elements such as central, terminal, corner, chaise longue, dormeuse and stools are available for an extremely wide proposal featuring a clearly horizontal progression with generous volumes matching plain and quilted surfaces. The modular elements of the programme, which are freely matched, can create strongly personalized solutions which are able to overturn, by enriching it, the classical sofa function within the domestic or contract areas. Much more than a collection of seating, Miller is a true and real furnishing sofa system which puts together the various padded elements - available in one depth, yet with different kind of structures, armrests and back - to open or closed storage units and bookcases in different materials. The three typologies of armrests define the relation between the seat elements and the integrated volumes: standard padded armrest, Open with fitting elements placed on floor and Top with fitting elements laid on the sofa structure.

Also available in Miller Double version.



### MILLER

**Struttura:** legno multistrato imbottito in poliuretano espanso indeformabile rivestito in tessuto protettivo accoppiato.  
**Cuscini seduta:** poliuretano espanso indeformabile.  
**Piano seduta trapuntato:** accoppiato a fibra sintetica.  
**Cuscini schienale:** piuma d'oca (Assopiuma).  
**Piedini:** neri.  
**Rivestimento:** sfoderabile in tessuto, fisso in pelle. Rivestimento trapuntato sfoderabile e lavabile esclusivamente a secco.  
**Profilo:** esclusivamente sul cuscino seduta, nello stesso materiale e colore del rivestimento. Su richiesta profilo in contrasto esclusivamente in Grosgrain.

### ACCESSORI:

| **libreria schienale:** composta da vani a giorno e vassoi non removibili in legno, con basamento in metallo verniciato color brunito. Da abbinare sul retro di qualsiasi elemento, non è fissato al divano.  
| **pouf volume:** collezione di pouf volume coordinati in differenti misure con rivestimento trapuntato in tessuto o pelle.  
| **tavolini volume pad:** volumi monoblocco in varie dimensioni in ceramica oppure rivestiti in cuoio.

**VERSIONE MILLER BRACCIOLO:** versione con bracciolo leggermente arrotondato

**Structure:** plywood padded with non-deformable polyurethane foam covered with doubled protective fabric.  
**Seat cushions:** non-deformable polyurethane foam.  
**Quilted top seat cover:** doubled with synthetic fibre layer.  
**Back cushions:** goose down (Assopiuma).  
**Feet:** black.  
**Cover:** removable in fabric, fix in leather. Quilted covers removable, dry clean only.  
**Piping:** on seat cushion only, in the same material and colour as the cover. On demand piping in contrast exclusively in Grosgrain.

### ACCESSORIES:

| **bookcase for back sofa:** composed by open compartments and non-removable trays in wood, with base in metal burnished painted. To be placed on the back of any element, it is not fixed to the sofa.  
| **pouf volume:** collection of coordinated pouf volume in different sizes with quilted cover either in fabric or leather.  
| **small table volume pad:** monobloc volumes in different sizes or covered in hide leather.

**VERSION MILLER ARMREST:** classical version with armrest slightly rounded.

### MILLER TOP / OPEN

**VERSIONE MILLER TOP:** struttura con top imbottito e schienale sporgente, che servono da appoggio e contenimento per accessori.

### ACCESSORI MILLER TOP:

Bracciolo CABINET  
 Bracciolo VOLUME SOFT  
 Bracciolo VOLUME PAD

**Varianti:** combinabile con gli altri elementi della collezione Miller.

**VERSIONE MILLER OPEN:** struttura con schienale sporgente, che serve da contenimento accessori posizionati a terra.

### ACCESSORI MILLER OPEN:

Bracciolo WOOD  
 Bracciolo DAY LOW

**Varianti:** combinabile con gli altri elementi della collezione Miller.

**VERSION MILLER TOP:** structure with top and longer back suitable for supporting and containing accessories.

### ACCESSORIES MILLER TOP:

Armrest CABINET  
 Armrest VOLUME SOFT  
 Armrest VOLUME PAD

**Variants:** to be combined with the other elements of the Miller Collection.

**VERSION MILLER OPEN:** structure with longer back suitable for containing elements resting on floor.

### ACCESSORIES MILLER OPEN:

Armrest WOOD  
 Armrest DAY LOW

**Variants:** to be combined with the other elements of the Miller Collection.

## MILLER SEDUTE / SEATS



### SEDUTA LISCIA / PLAIN SEAT

Ogni elemento seduta può avere rivestimento liscio.

Each seat element could have a plain cover.



### SEDUTA TRAPUNTATA / QUILTED SEAT

Ogni elemento seduta può avere un rivestimento con trapunta dedicata.

Each seat element could have a cover with a dedicated quilting.

## MILLER BRACCIOLO / ARMREST



Divani, terminali, chaises longues e dormeuses con versione classica del bracciolo, leggermente arrotondato. La collezione consiste in elementi freestanding e in elementi da utilizzare in composizione, tra cui anche elementi centrali.

Sofas, terminals, chaises longues and dormeuses with a classic, slightly rounded armrest version. The collection consists of freestanding elements and composition elements, including central elements.

## MILLER TOP ELEMENTI TOP / TOP ELEMENTS



Terminali, chaises longue, dormeuses e pouf caratterizzati da struttura con top imbottito e schienale sporgente, che servono da appoggio e contenimento per i loro accessori, che sono privi di piedini e assicurati al top tramite calamite:

**Bracciolo Volume Soft** (imbottito e trapuntato)

**Bracciolo Volume Pad** (in gres porcellanato effetto marmo, rivestito in cuoio oppure impiallacciato)

**Bracciolo Cabinet** (impiallacciato nelle finiture della collezione Frigerio)

Terminals, chaises longues, dormeuses and poufs characterised by a structure with upholstered top and longer backrest, used to support and contain their accessories, which are without feet and secured to the top by magnets:

**Volume Soft armrest** (padded and quilted)

**Volume Pad armrest** (in gres porcelain marble effect, in hide leather or veneered)

**Cabinet armrest** (veneered in the finishes of the Frigerio collection)

### VOLUME SOFT



### VOLUME PAD



### CABINET



## MILLER OPEN ELEMENTI OPEN / OPEN ELEMENTS



Terminali, chaises longue e dormeuses caratterizzati da struttura con schienale sporgente, che serve da contenimento per gli accessori:

**Bracciolo Day Low** (parte trapuntata in tessuto o pelle e parte libreria in impiallacciato nelle finiture della collezione Frigerio. Basamento in metallo color brunito)

**Bracciolo Wood** (impiallacciato nelle finiture della collezione Frigerio. Basamento in metallo color brunito)

Terminals, chaises longues and dormeuses characterised by a structure with longer backrest, used to contain their accessories:

**Day Low armrest** (quilted part in fabric or leather and bookcase part veneered in the finishes of the Frigerio collection. Base in metal burnished colour)

**Wood armrest** (veneered in the finishes of the Frigerio collection. Base in metal burnished colour)

### BRACCIOLO DAY LOW



### BRACCIOLO WOOD





## MILLER DOUBLE FULL BACK

Serie di elementi che hanno lo schienale interamente imbottito anche sul retro per consentire l'aggancio degli articoli "seduta" (senza schienale), consentendo la realizzazione di composizioni bifacciali. Gli elementi "seduta" non possono essere utilizzati come pouf in quanto, per motivi tecnici, sia l'imbottitura che il rivestimento sono rifiniti in modo particolare.

**Struttura:** legno multistrato imbottito in poliuretano espanso indeformabile rivestito in tessuto protettivo accoppiato.

**Cuscini seduta:** poliuretano espanso indeformabile.

**Piano seduta trapuntato:** accoppiato a fibra sintetica.

**Cuscini schienale:** piuma d'oca (Assopiuma).

**Piedini:** neri.

**Rivestimento:** sfoderabile in tessuto, fisso in pelle. Rivestimento trapuntato sfoderabile e lavabile esclusivamente a secco.

**Profilo:** esclusivamente sul cuscino seduta, nello stesso materiale e colore del rivestimento.

In caso di rivestimento in tessuto ALBA, LIPARI o RAVELLO, profilo disponibile esclusivamente in art. GROSGRAIN.

Collection of elements fully padded on both sides of the backrest to allow the fixing of the "seat elements" (without back), to create double-side compositions.

The seat elements cannot be used as poufs since for technical reasons both the padding and the covers are finished in a specific way.

**Structure:** plywood padded with non-deformable polyurethane foam covered with doubled protective fabric.

**Seat cushion:** non-deformable polyurethane foam.

**Quilted top seat:** doubled with synthetic fibre layer.

**Back cushions:** goose down (Assopiuma).

**Feet:** black.

**Cover:** removable in fabric, fix in leather. Quilted covers removable, dry clean only.

**Piping:** on seat cushion only, in the same material and colour as the cover.

In case of cover in fabric ALBA, LIPARI or RAVELLO, piping available exclusively in art. GROSGRAIN.

### ELEMENTI CON RETRO INTERAMENTE IMBOTTITO + ELEMENTI SEDUTA / ELEMENTS WITH FULL PADDED BACK + SEAT ELEMENTS



## MILLER DOUBLE SHAPED BACK

Serie di elementi che hanno lo schienale imbottito, ma **sagomato** sul retro per consentire l'aggancio degli articoli "seduta" (senza schienale), consentendo la realizzazione di composizioni bifacciali. Gli elementi "seduta" non possono essere utilizzati come pouf in quanto, per motivi tecnici, sia l'imbottitura che il rivestimento sono rifiniti in modo particolare.

**Struttura:** legno multistrato imbottito in poliuretano espanso indeformabile rivestito in tessuto protettivo accoppiato.

**Cuscini seduta:** poliuretano espanso indeformabile.

**Piano seduta trapuntato:** accoppiato a fibra sintetica.

**Cuscini schienale:** piuma d'oca (Assopiuma).

**Piedini:** neri.

**Rivestimento:** sfoderabile in tessuto, fisso in pelle.

Rivestimento trapuntato sfoderabile e lavabile esclusivamente a secco.

Collection of elements padded on both sides of the backrest, but shaped on the external part of the backrest, to allow the fixing of the "seat elements" (without back), to create double-side compositions. The seat elements cannot be used as poufs since for technical reasons both the padding and the covers are finished in a specific way.

**Structure:** plywood padded with non-deformable polyurethane foam covered with doubled protective fabric.

**Seat cushion:** non-deformable polyurethane foam.

**Quilted top seat:** doubled with synthetic fibre layer.

**Back cushions:** goose down (Assopiuma).

**Feet:** black.

**Cover:** removable in fabric, fix in leather. Quilted covers removable, dry clean only.

### ELEMENTI CON RETRO SAGOMATO + ELEMENTI SEDUTA TOP / ELEMENTS WITH SHAPED BACK + SEAT ELEMENTS TOP

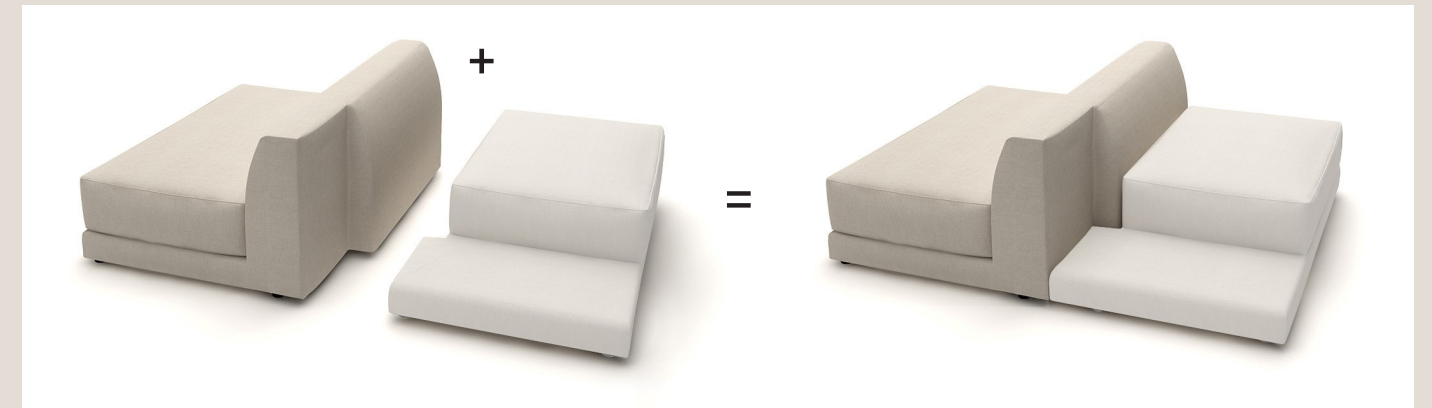

### ELEMENTI CON RETRO SAGOMATO + ELEMENTI SEDUTA / ELEMENTS WITH SHAPED BACK + SEAT ELEMENTS



## MILLER SOFA Design R&D Frigerio

MILLER / d. 100 cm

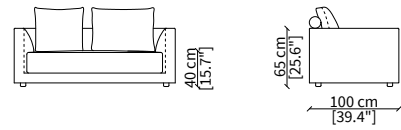

## DIVANI / SOFAS

15700 15400

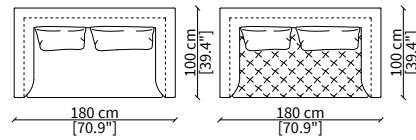

## DORMEUSES (FREESTANDING)

15721 15421 15722 15422

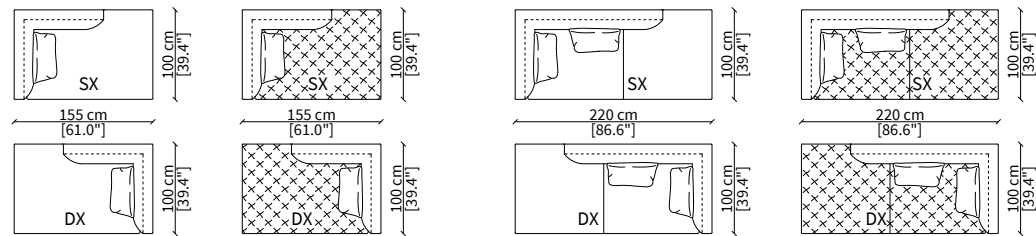

## DORMEUSES POUF (FREESTANDING)

15723 15610

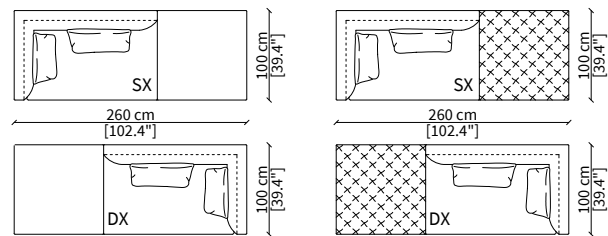

## CHAISES LONGUE (FREESTANDING)

15719 15419 15720 15420

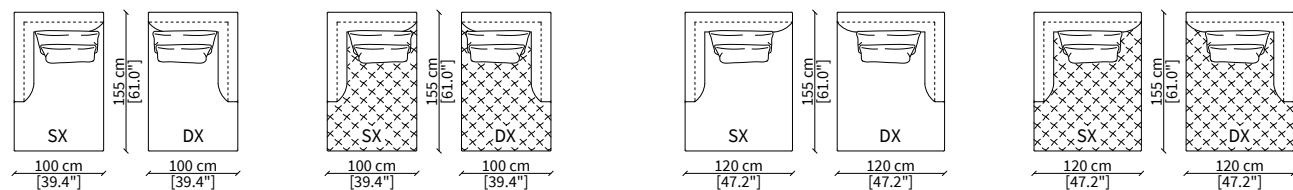

Dimensioni espresse in cm se non diversamente indicato.  
L'Azienda si riserva il diritto di apportare modifiche ai modelli senza preavviso.  
Tolleranza sulle misure indicate di +/- 2%.

Dimensions in centimeter if not differently indicated.  
The Company reserves the right to change the models without any advance notice.  
Tolerance on the given sizes +/- 2%.

## MILLER SOFA Design R&D Frigerio

## ELEMENTI TERMINALI / TERMINAL ELEMENTS

15713 15714 15715 15716 15717 15718

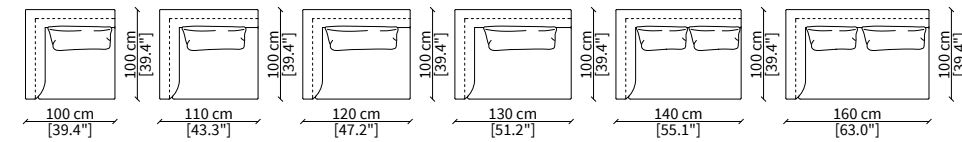

15413 15414 15415 15416 15417 15418

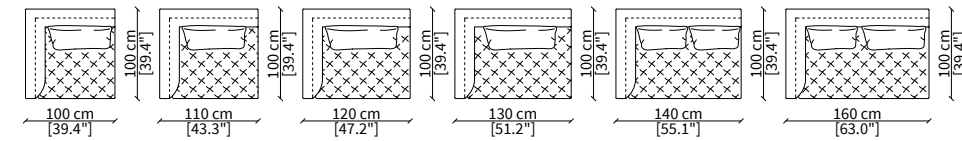

## ELEMENTI CENTRALI / CENTRAL ELEMENTS

15701 15702 15703 15704 15705 15706

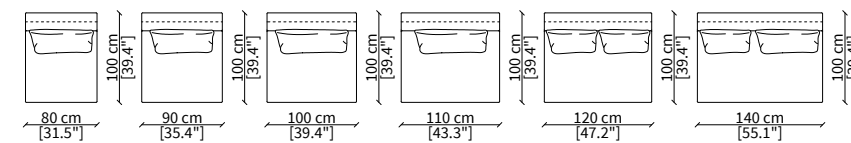

15401 15402 15403 15404 15405 15406

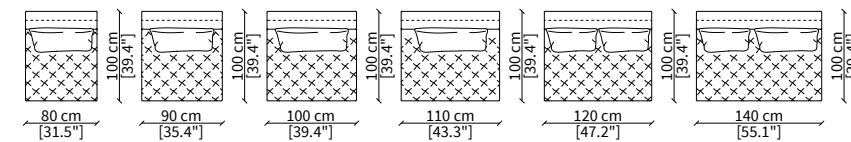

## CENTRALI DORMEUSE / CENTRAL DORMEUSES

15709 15409 15710 15410

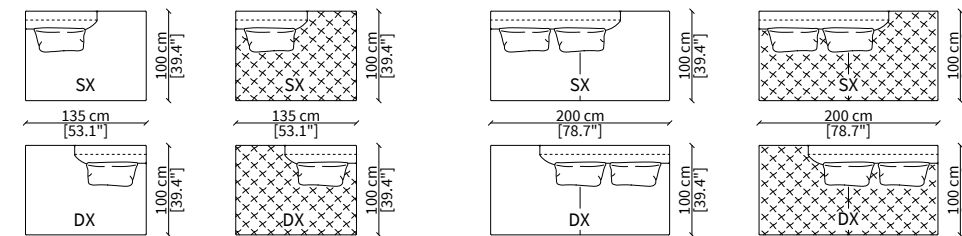

Dimensioni espresse in cm se non diversamente indicato.  
L'Azienda si riserva il diritto di apportare modifiche ai modelli senza preavviso.  
Tolleranza sulle misure indicate di +/- 2%.

Dimensions in centimeter if not differently indicated.  
The Company reserves the right to change the models without any advance notice.  
Tolerance on the given sizes +/- 2%.

**MILLER SOFA**  
Design R&D Frigerio

## DORMEUSE POUF CENTRALI / CENTRAL DORMEUSES POUF

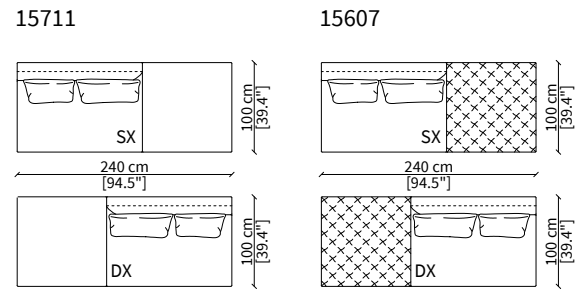

## CHAISES LONGUE CENTRALI / CENTRAL CHAISES LONGUE

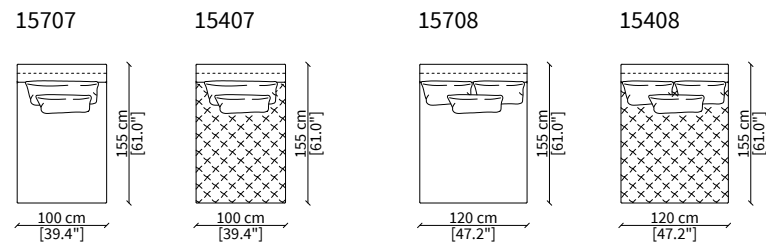

## ELEMENTI ANGOLO QUADRO / SQUARE CORNER ELEMENTS

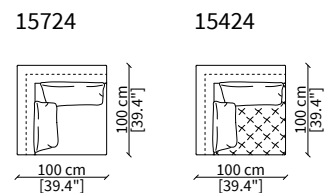

## ELEMENTI ANGOLO CURVO / CURVED CORNER ELEMENTS

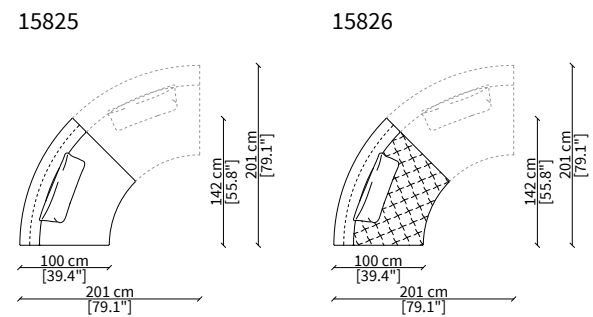

## ELEMENTI TERMINALI ANGOLO / TERMINAL CORNER ELEMENTS

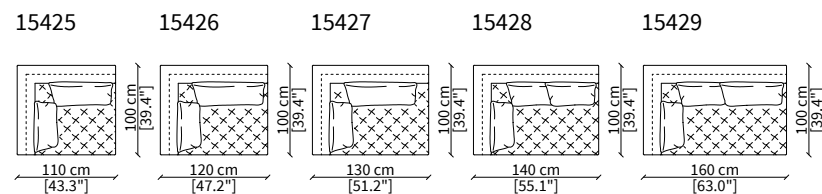
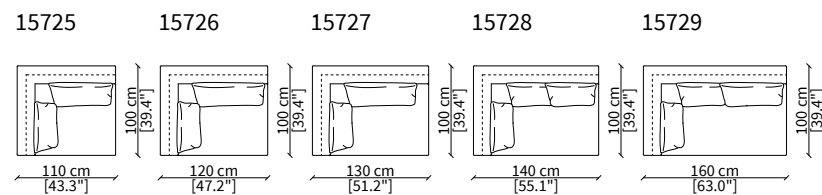

Dimensioni espresse in cm se non diversamente indicato.  
L'Azienda si riserva il diritto di apportare modifiche ai modelli senza preavviso.  
Tolleranza sulle misure indicate di +/- 2%.

Dimensions in centimeter if not differently indicated.  
The Company reserves the right to change the models without any advance notice.  
Tolerance on the given sizes +/- 2%.

**MILLER SOFA**  
Design R&D Frigerio

## ELEMENTI DORMEUSE ANGOLO / DORMEUSE CORNER ELEMENTS

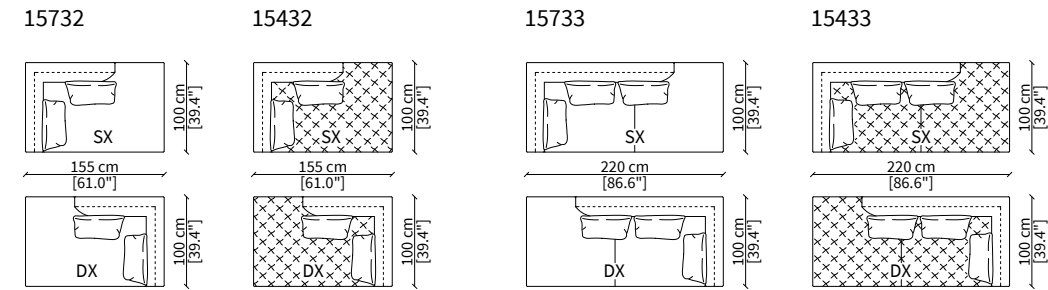

## ELEMENTI DORMEUSE POUF ANGOLO / DORMEUSE POUF CORNER ELEMENTS

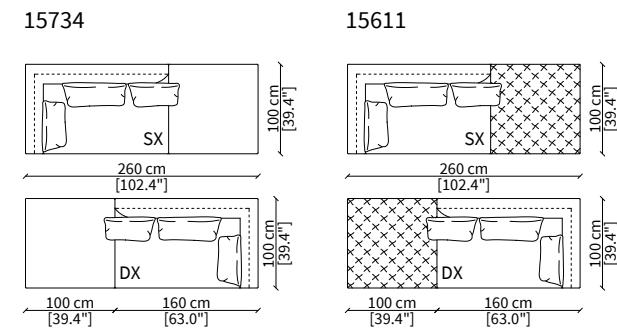

## CHAISES LONGUE ANGOLO / CHAISES LONGUE CORNER

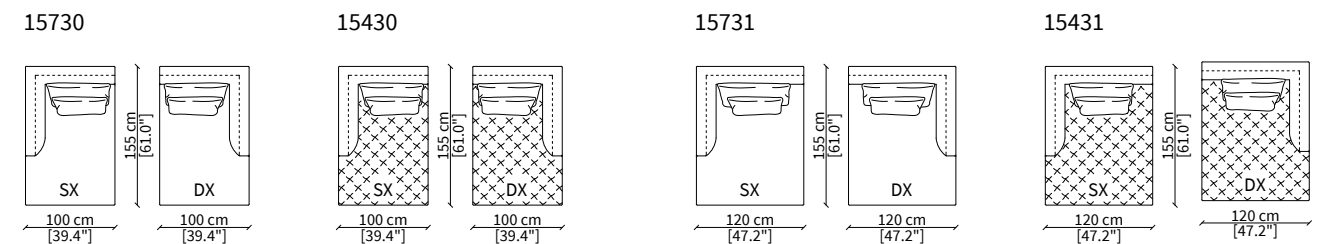

Dimensioni espresse in cm se non diversamente indicato.  
L'Azienda si riserva il diritto di apportare modifiche ai modelli senza preavviso.  
Tolleranza sulle misure indicate di +/- 2%.

Dimensions in centimeter if not differently indicated.  
The Company reserves the right to change the models without any advance notice.  
Tolerance on the given sizes +/- 2%.

**MILLER SOFA**  
Design R&D Frigerio

## POUFS

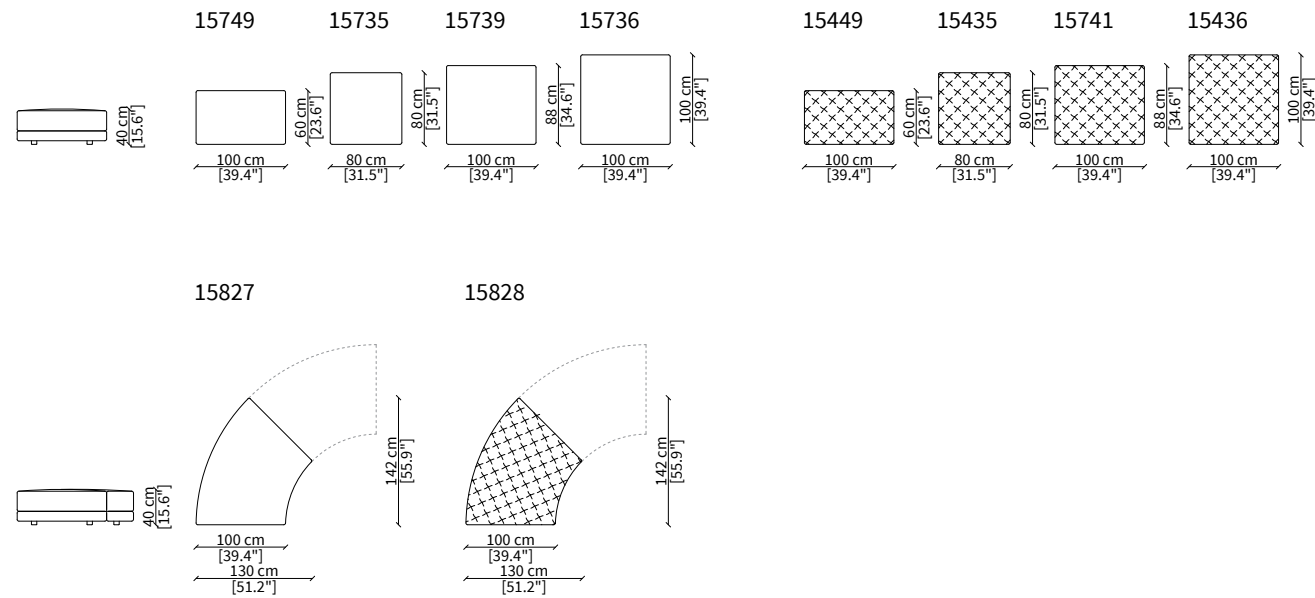

## VOLUMI POUF / POUF VOLUMES

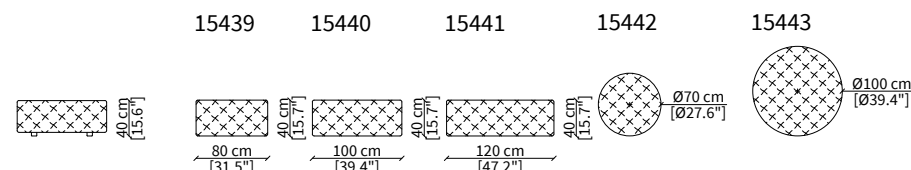

## TAVOLINI / SMALL TABLES

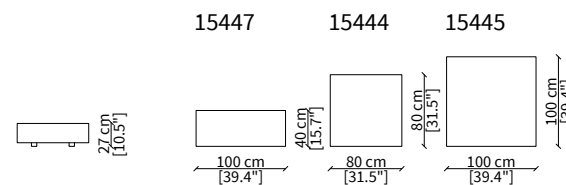

## CUSCINI / CUSHIONS

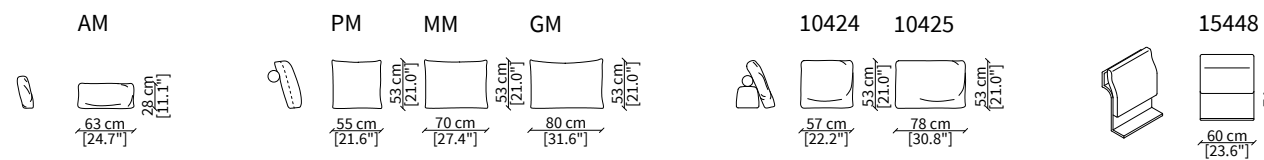

## LIBRERIA RETRO DIVANO / BOOKCASE FOR BACKREST

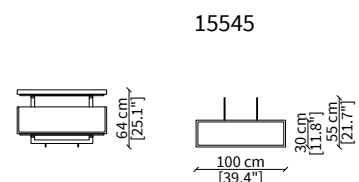

Dimensioni espresse in cm se non diversamente indicato.  
L'Azienda si riserva il diritto di apportare modifiche ai modelli senza preavviso.  
Tolleranza sulle misure indicate di +/- 2%.

Dimensions in centimeter if not differently indicated.  
The Company reserves the right to change the models without any advance notice.  
Tolerance on the given sizes +/- 2%.

**MILLER SOFA**  
Design R&D Frigerio



## MILLER TOP SOFA

Design R&D Frigerio

### MILLER TOP / d. 100 cm

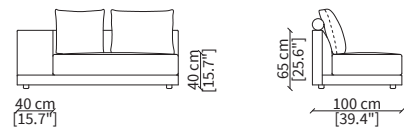

### ELEMENTI TERMINALI TOP / TERMINAL TOP ELEMENTS

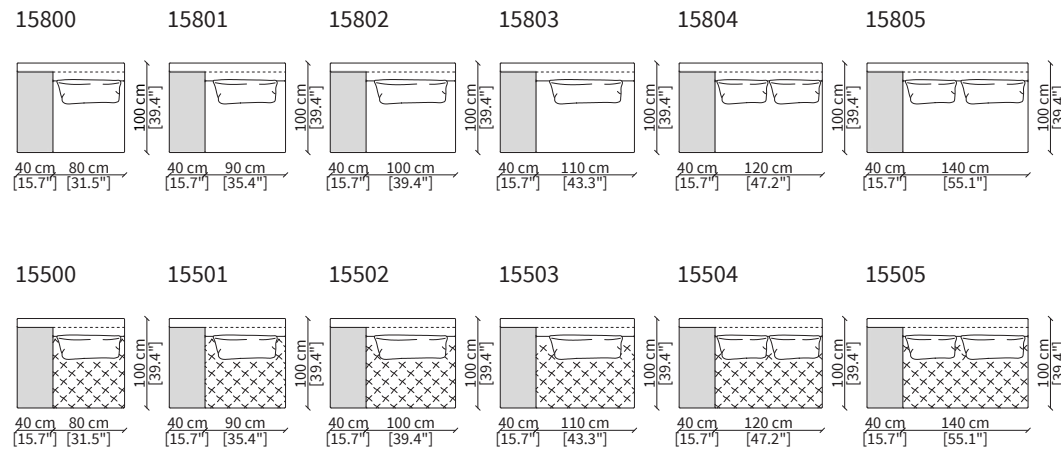

### DORMEUSES TOP

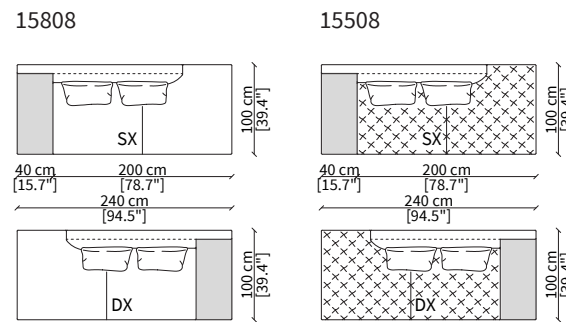

### DORMEUSES POUF TOP

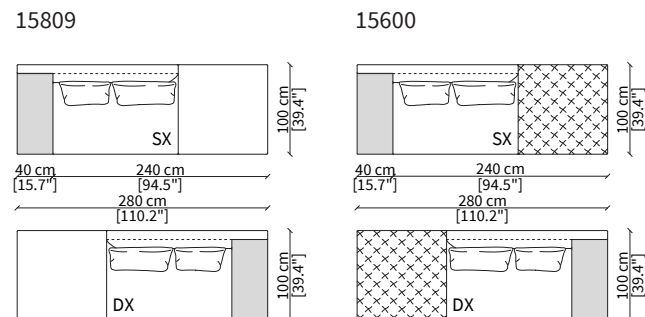

Dimensioni espresse in cm se non diversamente indicato.  
L'Azienda si riserva il diritto di apportare modifiche ai modelli senza preavviso.  
Tolleranza sulle misure indicate di +/- 2%.

Dimensions in centimeter if not differently indicated.  
The Company reserves the right to change the models without any advance notice.  
Tolerance on the given sizes +/- 2%.

## MILLER TOP SOFA

Design R&D Frigerio

### CHAISES LONGUE TOP

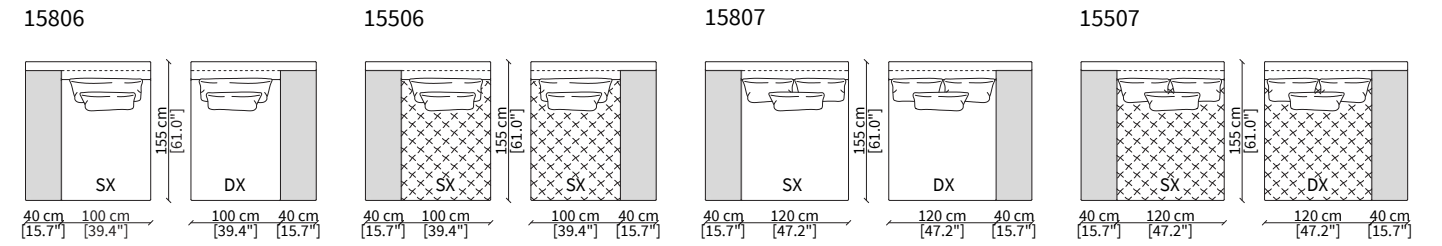

### POUFS TOP

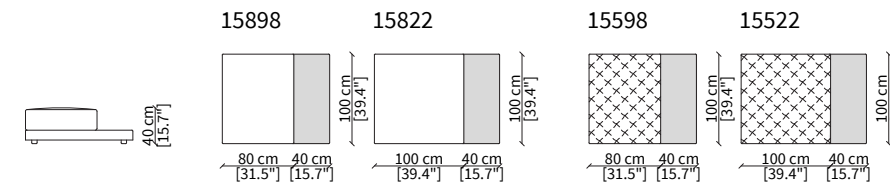

### ACCESSORI - VOLUME SOFT / ACCESSORIES - VOLUME SOFT

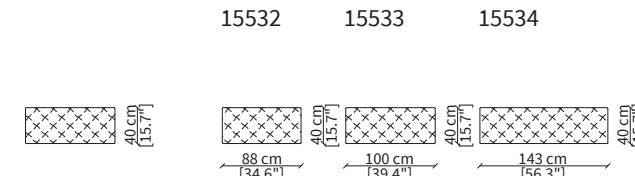

### ACCESSORI - VOLUME PAD / ACCESSORIES - VOLUME PAD

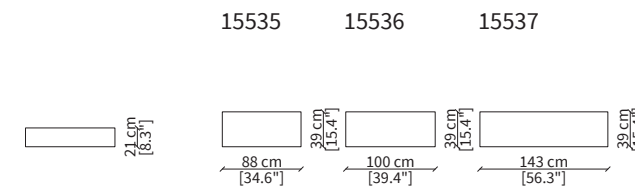

### ACCESSORI - CABINET / ACCESSORIES - CABINET

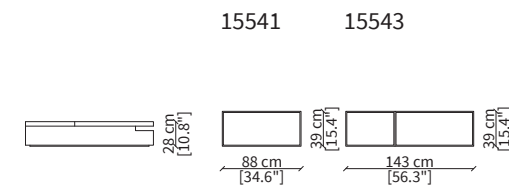

Dimensioni espresse in cm se non diversamente indicato.  
L'Azienda si riserva il diritto di apportare modifiche ai modelli senza preavviso.  
Tolleranza sulle misure indicate di +/- 2%.

Dimensions in centimeter if not differently indicated.  
The Company reserves the right to change the models without any advance notice.  
Tolerance on the given sizes +/- 2%.

## MILLER OPEN SOFA

Design R&D Frigerio

### MILLER OPEN / d. 100 cm

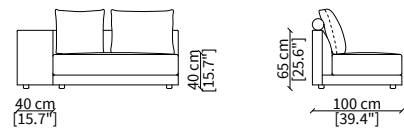

### ELEMENTI TERMINALI OPEN / TERMINAL OPEN ELEMENTS

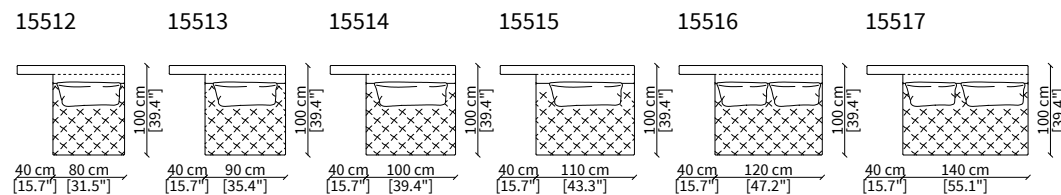
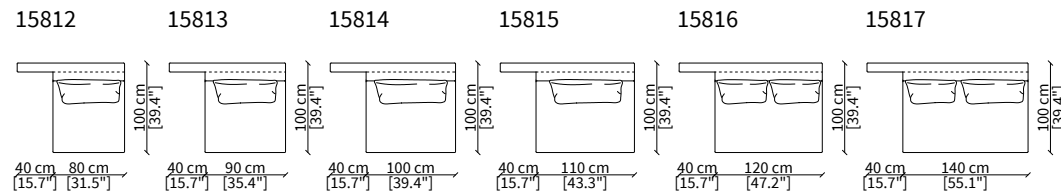

### DORMEUSES OPEN

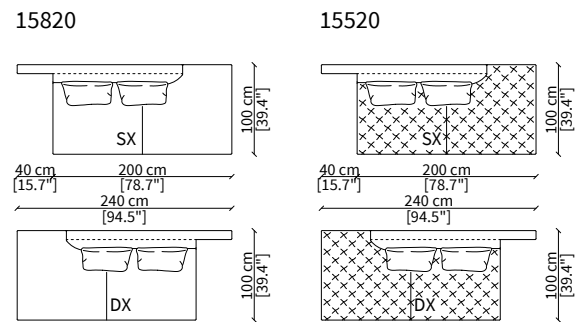

### DORMEUSES POUF OPEN

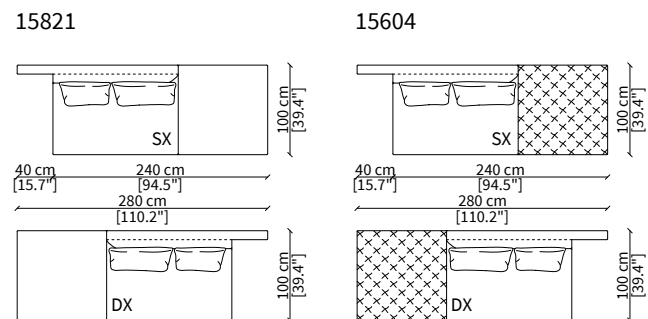

Dimensioni espresse in cm se non diversamente indicato.  
L'Azienda si riserva il diritto di apportare modifiche ai modelli senza preavviso.  
Tolleranza sulle misure indicate di +/- 2%.

Dimensions in centimeter if not differently indicated.  
The Company reserves the right to change the models without any advance notice.  
Tolerance on the given sizes +/- 2%.

## MILLER OPEN SOFA

Design R&D Frigerio

### CHAIRES LONGUE OPEN

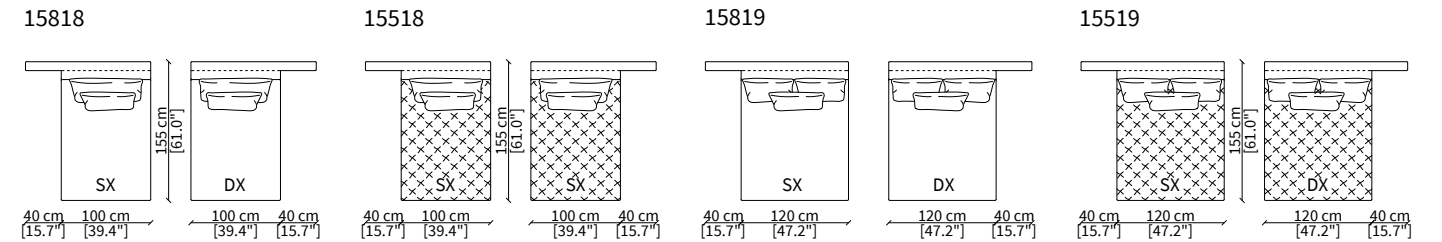

### BRACCIOLO DAY LOW / ARMREST DAY LOW

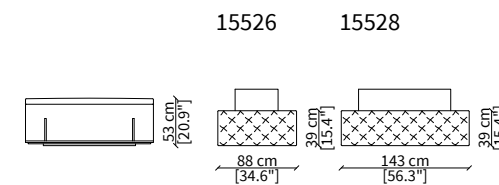

### BRACCIOLO WOOD / ARMREST WOOD

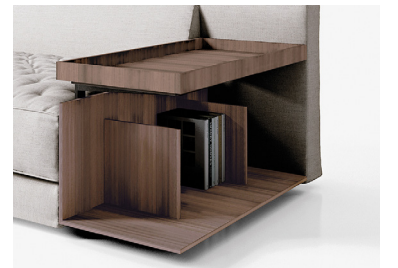
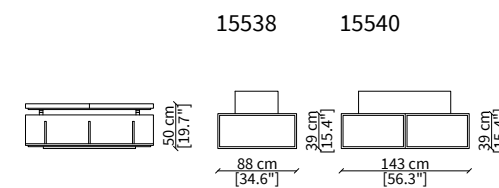

Dimensioni espresse in cm se non diversamente indicato.  
L'Azienda si riserva il diritto di apportare modifiche ai modelli senza preavviso.  
Tolleranza sulle misure indicate di +/- 2%.

Dimensions in centimeter if not differently indicated.  
The Company reserves the right to change the models without any advance notice.  
Tolerance on the given sizes +/- 2%.



**MILLER SOFA**  
Design R&D Frigerio

## DETTAGLI DEGLI ELEMENTI ANGOLO / DETAILS OF CORNER ELEMENTS

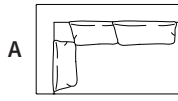

**A** angolo  
corner

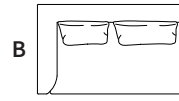

**B** bracciolo  
armrest

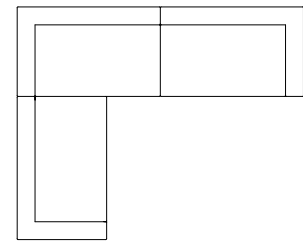

**CORRETTO /  
CORRECT**

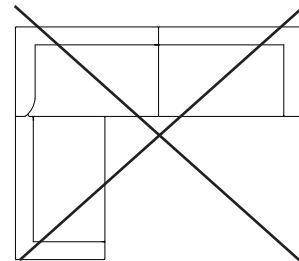

**ERRATO /  
WRONG**

## ESEMPI DI COMPOSIZIONE AD ANGOLO / EXAMPLES OF CORNER COMPOSITIONS

Le composizioni ad angolo possono essere così realizzate:  
Corner composition can be built as follows:

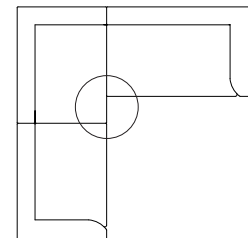

**15724 (Plain)**  
**15424 (Quilt)**

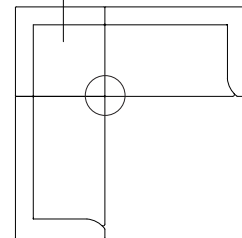

1. utilizzando gli elementi “terminali angolo”, “dormeuses angolo”,  
“chaises longue angolo”.

1. by using the elements “terminals corner”, “dormeuses corner” or  
“chaises longues corner”.

2. utilizzando l'angolo (art. **15724 Plain** e art. **15424 Quilt**) per un  
allineamento preciso delle sedute.

2. by using the corner (art. **15724 Plain** and art. **15424 Quilt**) for a  
perfect alignment of the seats.

Dimensioni espresse in cm se non diversamente indicato.  
L'Azienda si riserva il diritto di apportare modifiche ai modelli senza preavviso.  
Tolleranza sulle misure indicate di +/- 2%.

Dimensions in centimeter if not differently indicated.  
The Company reserves the right to change the models without any advance notice.  
Tolerance on the given sizes +/- 2%.

**MILLER SOFA**  
Design R&D Frigerio

## COMPOSIZIONE 1 / COMPOSITION 1

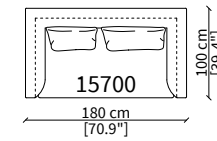

CODICI / CODES: **15700**

## COMPOSIZIONE 2 / COMPOSITION 2

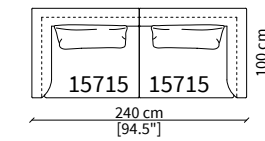

CODICI / CODES: **15715 x 2**

## COMPOSIZIONE 3 / COMPOSITION 3

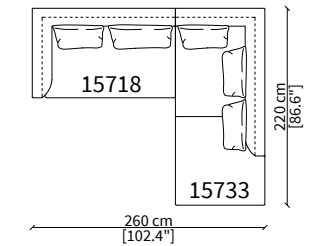

CODICI / CODES: **15718, 15733**

## COMPOSIZIONE 4 / COMPOSITION 4

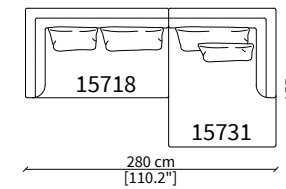

CODICI / CODES: **15718, 15731**

## COMPOSIZIONE 5 / COMPOSITION 5

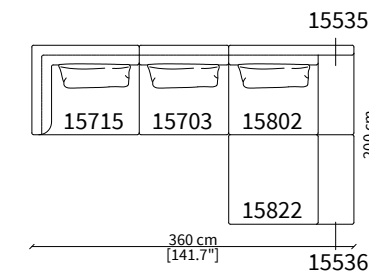

CODICI / CODES: **15715, 15703, 15802,  
15535, 15536**

## COMPOSIZIONE 6 / COMPOSITION 6

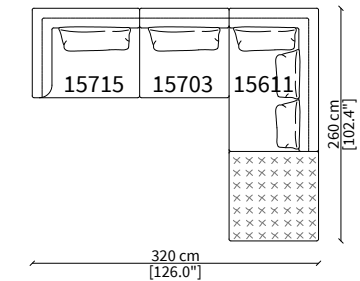

CODICI / CODES: **15715, 15703, 15611**

## COMPOSIZIONE 7 / COMPOSITION 7

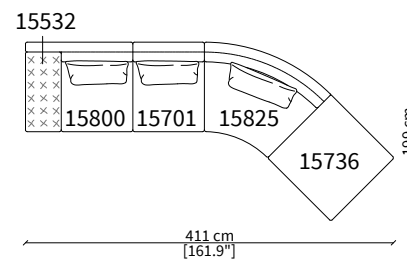

CODICI / CODES: **15532, 15800, 15701,  
15825, 15736**

## COMPOSIZIONE 8 / COMPOSITION 8

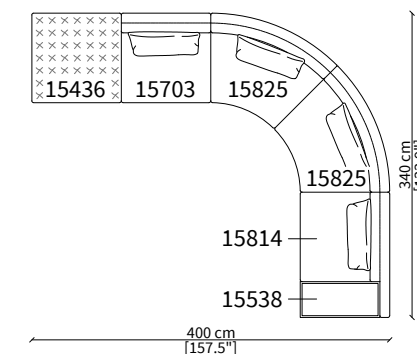

CODICI / CODES: **15436, 15703, 15825 x 2,  
15814, 15538**

## COMPOSIZIONE 9 / COMPOSITION 9

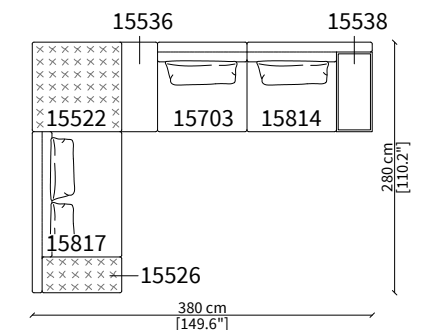

CODICI / CODES: **15526, 15817, 15522,  
15536, 15703, 15814, 15538**

Dimensioni espresse in cm se non diversamente indicato.  
L'Azienda si riserva il diritto di apportare modifiche ai modelli senza preavviso.  
Tolleranza sulle misure indicate di +/- 2%.

Dimensions in centimeter if not differently indicated.  
The Company reserves the right to change the models without any advance notice.  
Tolerance on the given sizes +/- 2%.

Per la gamma completa di materiali è possibile consultare il nostro sito web [www.frigerio.com](http://www.frigerio.com)  
The full range of materials can be found on our website at [www.frigerio.com](http://www.frigerio.com).

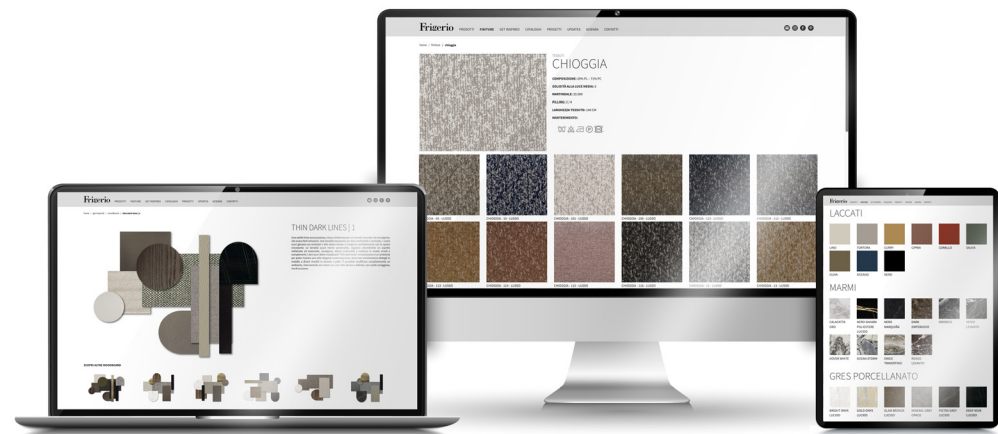

[WWW.FRIGERIO.COM](http://WWW.FRIGERIO.COM)

# Frigerio

Via Sant'Agata 63  
22066 Mariano Comense (CO) - Italy  
Tel. +39 031 5481225  
[info@frigerio.com](mailto:info@frigerio.com)  
[www.frigerio.com](http://www.frigerio.com)