

Frigerio

MILLER POUF

Design R&D Frigerio

Parte dell'ampia collezione omonima di divani, i pouf Miller si caratterizzano per l'elegante lavorazione trapuntata. Dalla grande versatilità estetica e funzionale, sono perfetti in ogni ambiente: dalla zona giorno alla zona notte. La struttura è in legno imbottita in poliuretano espanso indeformabile con rivestimento in tessuto interamente sfoderabile o fisso in pelle.

Being part of the wide collection of the namesake sofa's, the poufs Miller feature the elegant quilting manufacturing. Having a great versatility both aesthetical and functional, they are perfect in every environment: from the living to the night areas. The wooden structure is padded in non-deformable polyurethane with removable fabric cover or fixed in leather.

Struttura: legno multistrato imbottito in poliuretano espanso indeformabile rivestito in tessuto protettivo accoppiato.

Piedini: neri.

Rivestimento: trapuntato, accoppiato a fibra sintetica. Sfoderabile in tessuto, lavabile esclusivamente a secco. Fisso in pelle.

Structure: plywood padded with non-deformable polyurethane foam covered with doubled protective fabric.

Feet: black.

Cover: quilted, doubled with synthetic fibre layer. Removable in fabric, dry clean only. Fix in leather.



MILLER POUF

Design R&D Frigerio

VOLUMI POUF / POUF VOLUMES

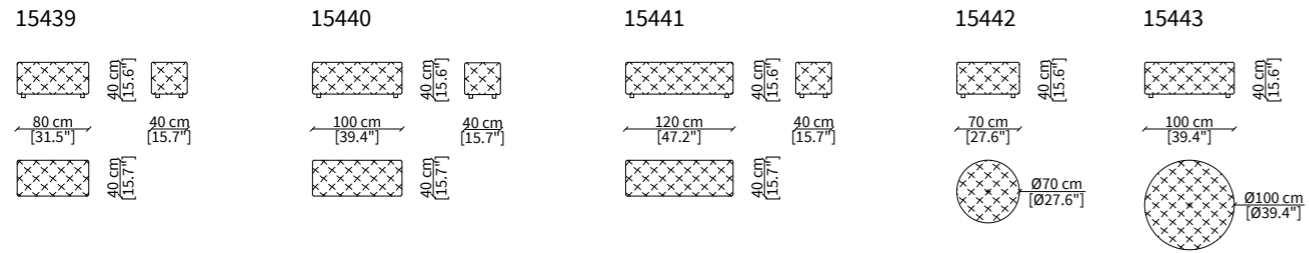

MILLER SOFA

Design R&D Frigerio

MILLER / d. 100 cm

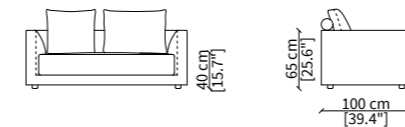

DIVANI / SOFAS

15700 15400

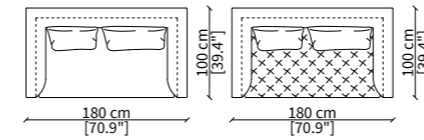

DORMEUSES (FREESTANDING)

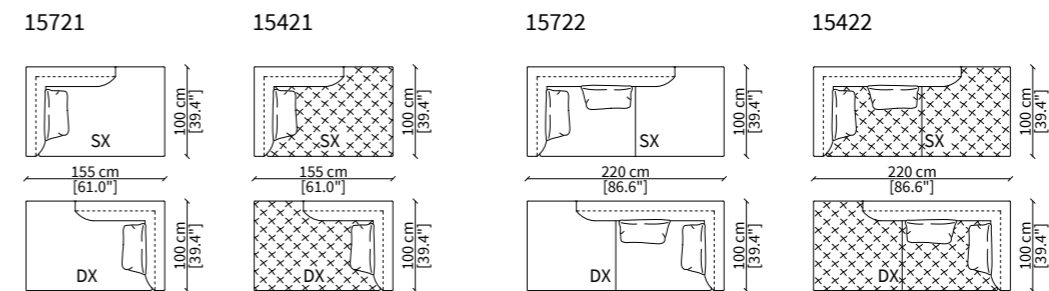

DORMEUSES POUF (FREESTANDING)

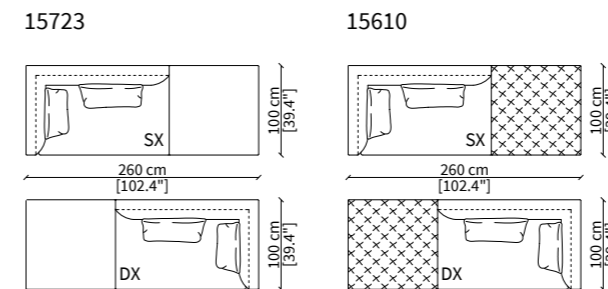

CHAISES LONGUE (FREESTANDING)

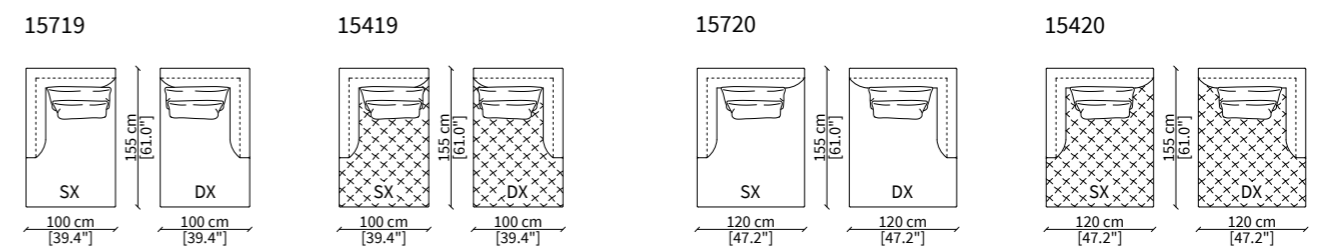

Dimensioni espresse in cm se non diversamente indicato.
L'Azienda si riserva il diritto di apportare modifiche ai modelli senza preavviso.
Tolleranza sulle misure indicate di +/- 2%.

Dimensions in centimeter if not differently indicated.
The Company reserves the right to change the models without any advance notice.
Tolerance on the given sizes +/- 2%.

Dimensioni espresse in cm se non diversamente indicato.
L'Azienda si riserva il diritto di apportare modifiche ai modelli senza preavviso.
Tolleranza sulle misure indicate di +/- 2%.

Dimensions in centimeter if not differently indicated.
The Company reserves the right to change the models without any advance notice.
Tolerance on the given sizes +/- 2%.

MILLER SOFA
Design R&D Frigerio

ELEMENTI TERMINALI / TERMINAL ELEMENTS

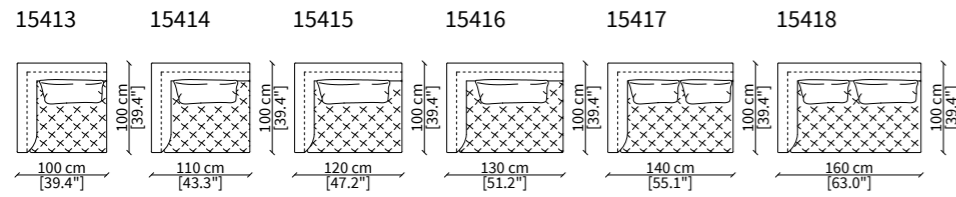
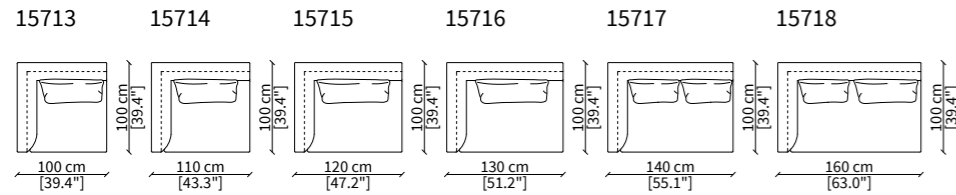

ELEMENTI CENTRALI / CENTRAL ELEMENTS

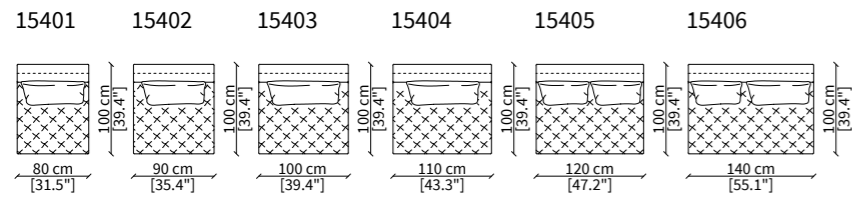
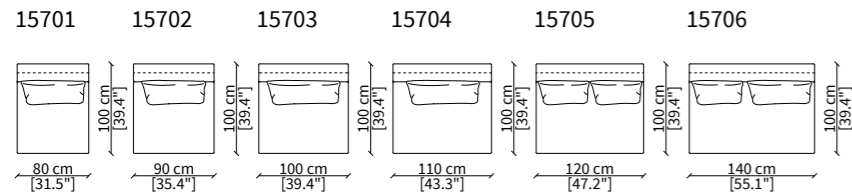

CENTRALI DORMEUSE / CENTRAL DORMEUSES

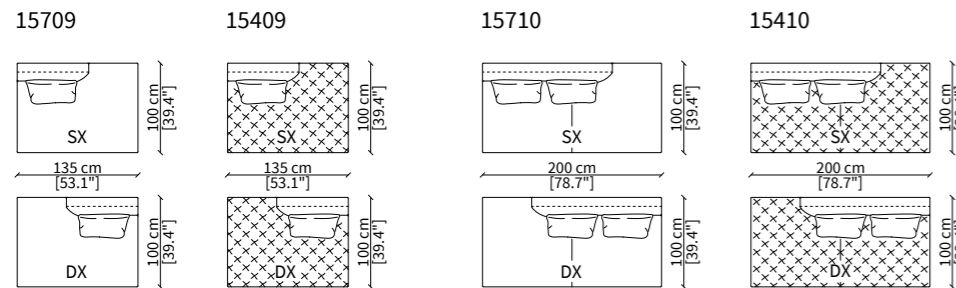

Dimensioni espresse in cm se non diversamente indicato.
L'Azienda si riserva il diritto di apportare modifiche ai modelli senza preavviso.
Tolleranza sulle misure indicate di +/- 2%.

Dimensions in centimeter if not differently indicated.
The Company reserves the right to change the models without any advance notice.
Tolerance on the given sizes +/- 2%.

MILLER SOFA
Design R&D Frigerio

DORMEUSE POUF CENTRALI / CENTRAL DORMEUSES POUF

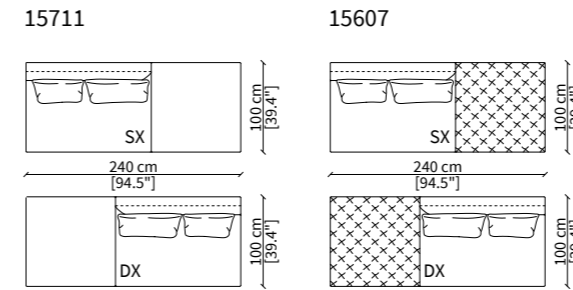

CHAISES LONGUE CENTRALI / CENTRAL CHAISES LONGUE

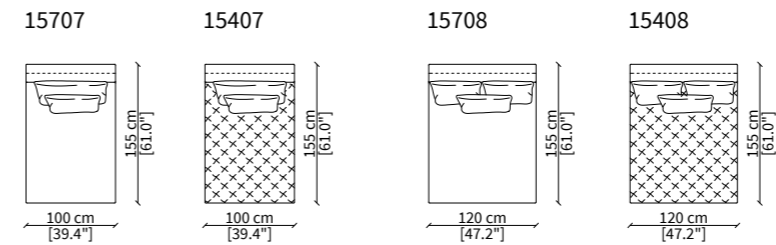

ELEMENTI ANGOLO QUADRO / SQUARE CORNER ELEMENTS

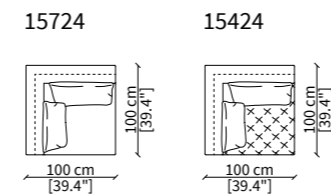

ELEMENTI ANGOLO CURVO / CURVED CORNER ELEMENTS

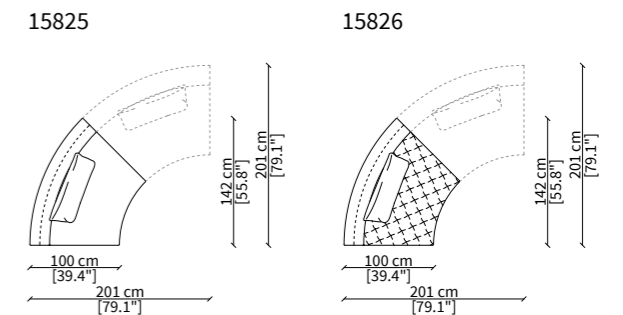

ELEMENTI TERMINALI ANGOLO / TERMINAL CORNER ELEMENTS

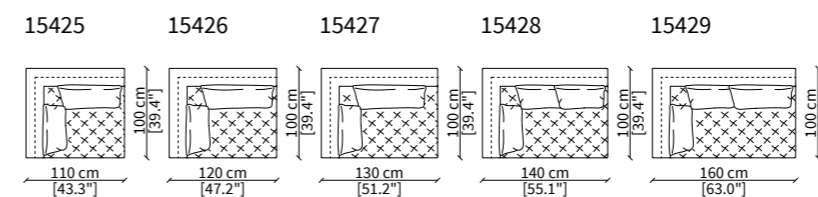
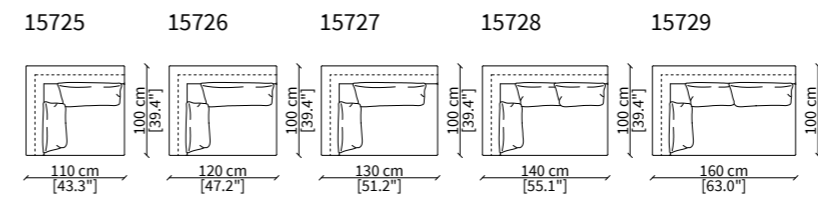

Dimensioni espresse in cm se non diversamente indicato.
L'Azienda si riserva il diritto di apportare modifiche ai modelli senza preavviso.
Tolleranza sulle misure indicate di +/- 2%.

Dimensions in centimeter if not differently indicated.
The Company reserves the right to change the models without any advance notice.
Tolerance on the given sizes +/- 2%.

MILLER SOFA
Design R&D Frigerio

ELEMENTI DORMEUSE ANGOLO / DORMEUSE CORNER ELEMENTS

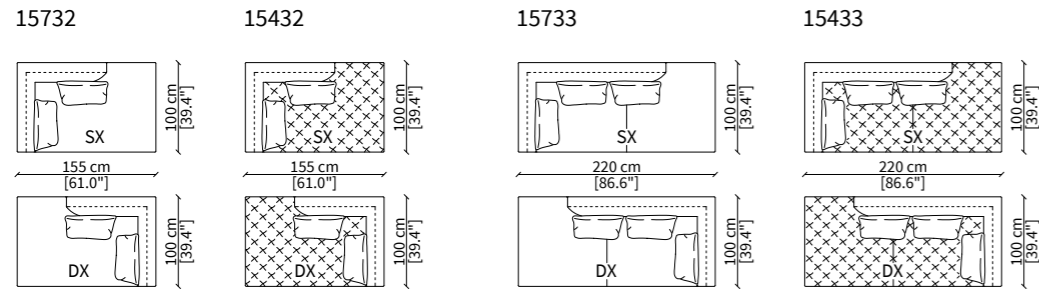

ELEMENTI DORMEUSE POUF ANGOLO / DORMEUSE POUF CORNER ELEMENTS

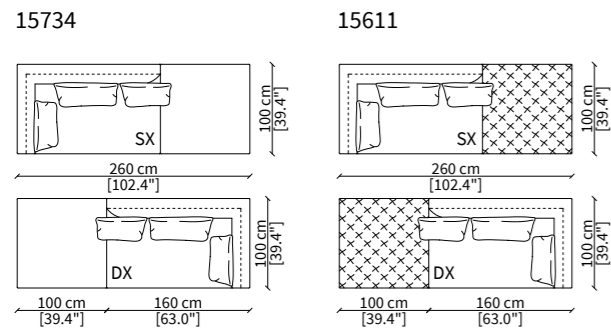

CHAISES LONGUE ANGOLO / CHAISES LONGUE CORNER

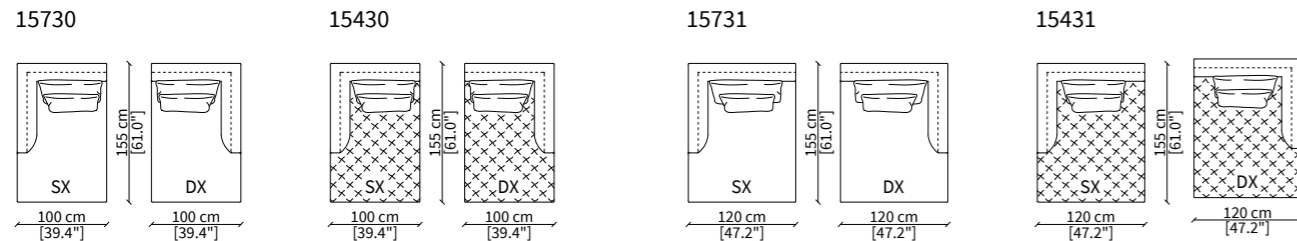

Dimensioni espresse in cm se non diversamente indicato.
L'Azienda si riserva il diritto di apportare modifiche ai modelli senza preavviso.
Tolleranza sulle misure indicate di +/- 2%.

Dimensions in centimeter if not differently indicated.
The Company reserves the right to change the models without any advance notice.
Tolerance on the given sizes +/- 2%.

MILLER SOFA
Design R&D Frigerio

POUFS

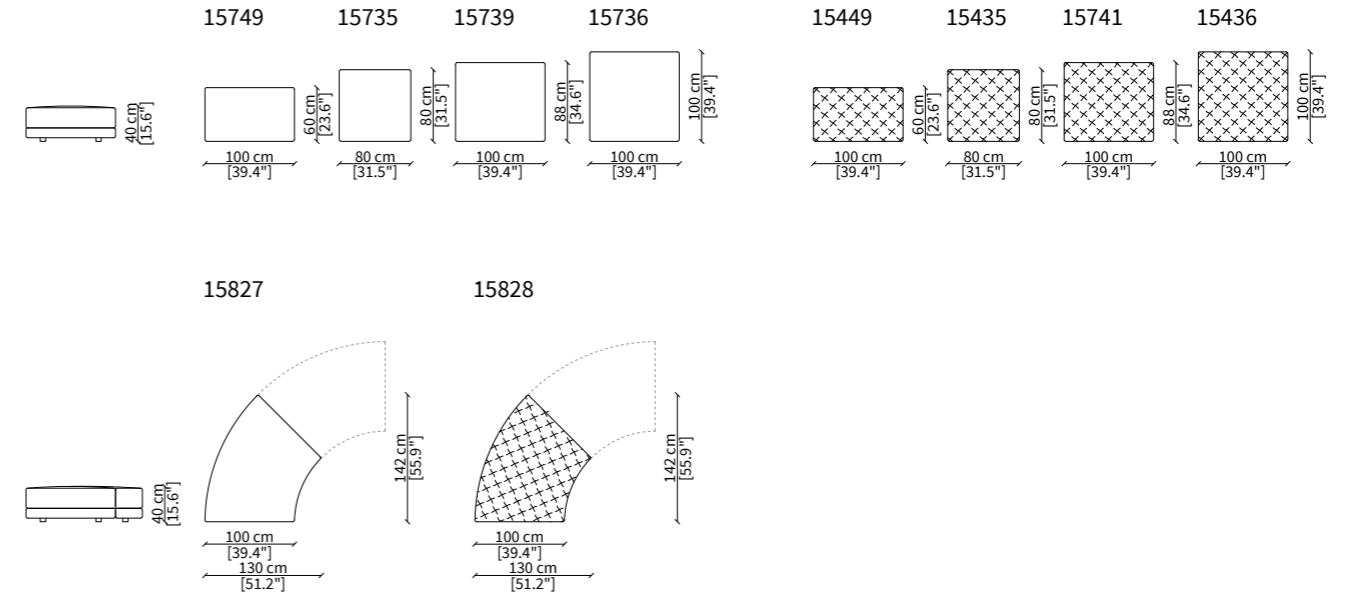

VOLUMI POUF / POUF VOLUMES

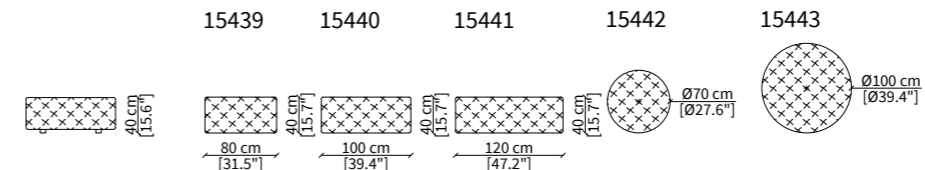

TAVOLINI / SMALL TABLES

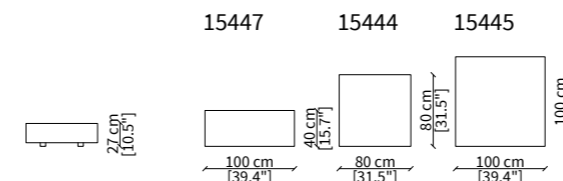

CUSCINI / CUSHIONS

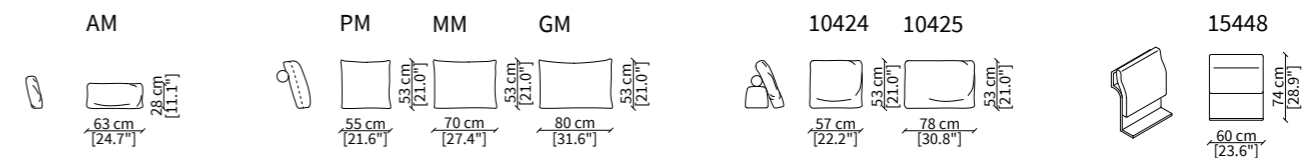

LIBRERIA RETRO DIVANO / BOOKCASE FOR BACKREST

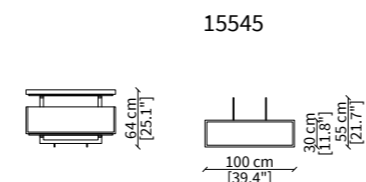

Dimensioni espresse in cm se non diversamente indicato.
L'Azienda si riserva il diritto di apportare modifiche ai modelli senza preavviso.
Tolleranza sulle misure indicate di +/- 2%.

Dimensions in centimeter if not differently indicated.
The Company reserves the right to change the models without any advance notice.
Tolerance on the given sizes +/- 2%.

MILLER TOP SOFA

Design R&D Frigerio

MILLER TOP / d. 100 cm

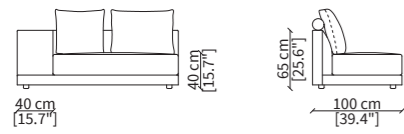

ELEMENTI TERMINALI TOP / TERMINAL TOP ELEMENTS

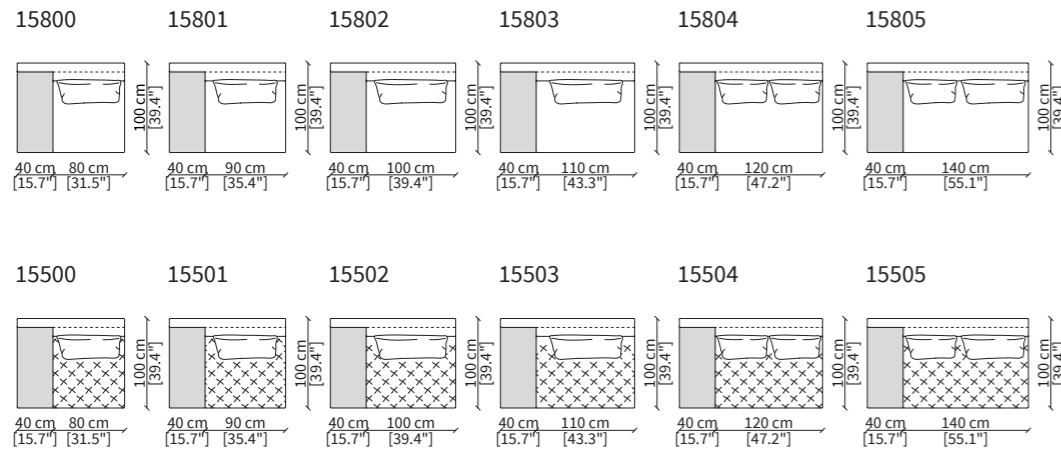

DORMEUSES TOP

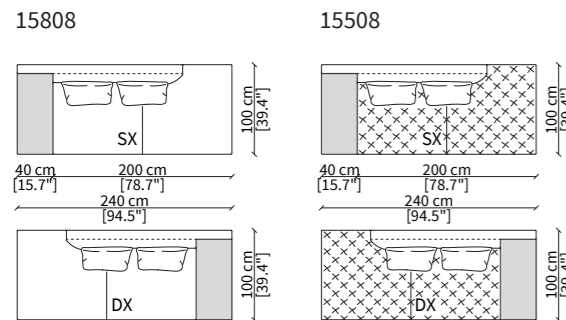

DORMEUSES POUF TOP

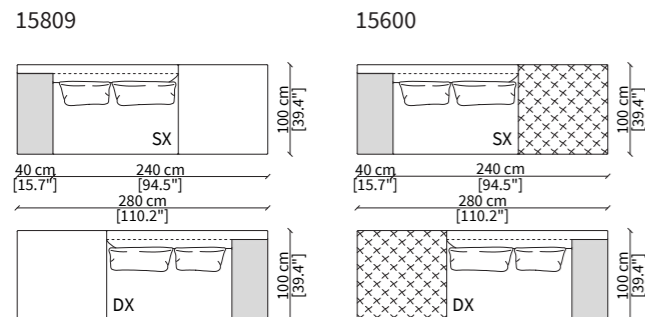

Dimensioni espresse in cm se non diversamente indicato.
L'Azienda si riserva il diritto di apportare modifiche ai modelli senza preavviso.
Tolleranza sulle misure indicate di +/- 2%.

Dimensions in centimeter if not differently indicated.
The Company reserves the right to change the models without any advance notice.
Tolerance on the given sizes +/- 2%.

MILLER TOP SOFA

Design R&D Frigerio

CHAISES LONGUE TOP

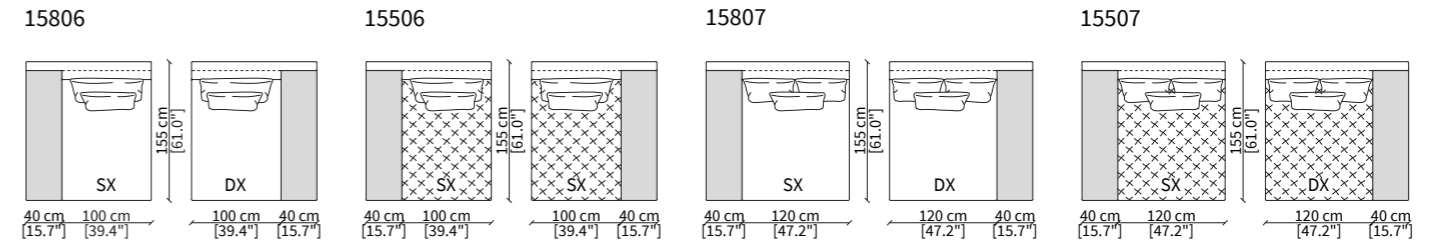

POUFS TOP

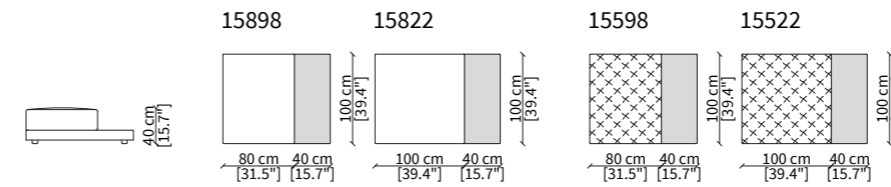

ACCESSORI - VOLUME SOFT / ACCESSORIES - VOLUME SOFT

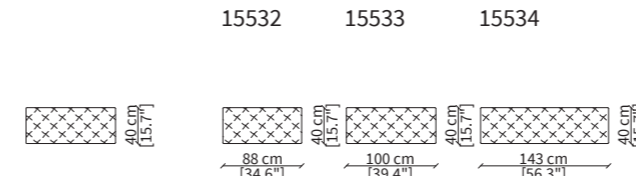

ACCESSORI - VOLUME PAD / ACCESSORIES - VOLUME PAD

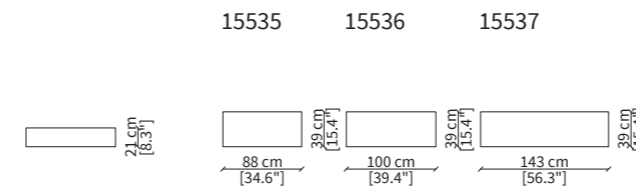

ACCESSORI - CABINET / ACCESSORIES - CABINET

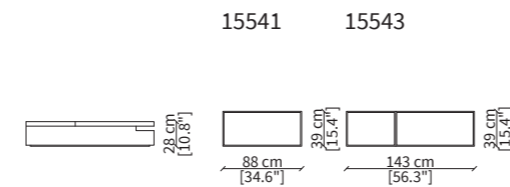

Dimensioni espresse in cm se non diversamente indicato.
L'Azienda si riserva il diritto di apportare modifiche ai modelli senza preavviso.
Tolleranza sulle misure indicate di +/- 2%.

Dimensions in centimeter if not differently indicated.
The Company reserves the right to change the models without any advance notice.
Tolerance on the given sizes +/- 2%.

MILLER OPEN SOFA

Design R&D Frigerio

MILLER OPEN / d. 100 cm

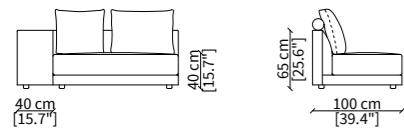

ELEMENTI TERMINALI OPEN / TERMINAL OPEN ELEMENTS

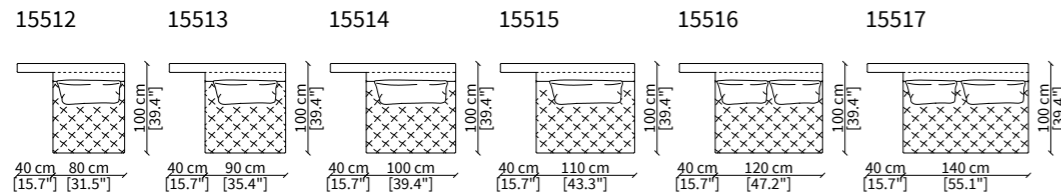
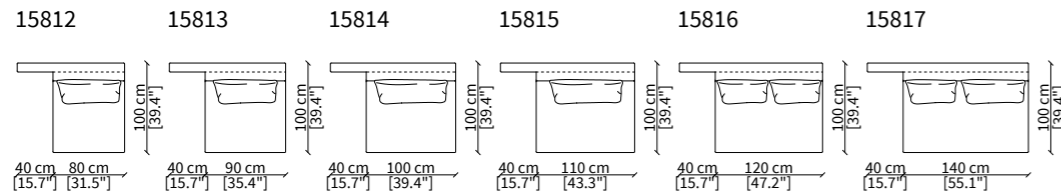

DORMEUSES OPEN

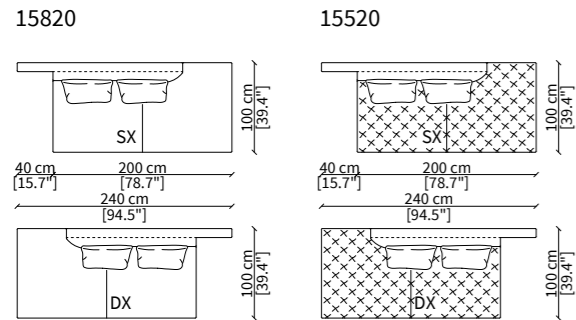

DORMEUSES POUF OPEN

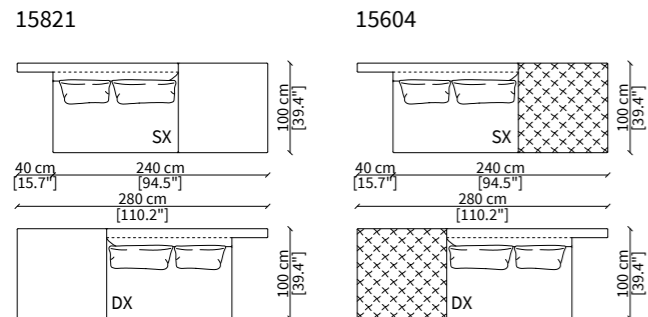

Dimensioni espresse in cm se non diversamente indicato.
L'Azienda si riserva il diritto di apportare modifiche ai modelli senza preavviso.
Tolleranza sulle misure indicate di +/- 2%.

Dimensions in centimeter if not differently indicated.
The Company reserves the right to change the models without any advance notice.
Tolerance on the given sizes +/- 2%.

MILLER OPEN SOFA

Design R&D Frigerio

CHAIRES LONGUE OPEN

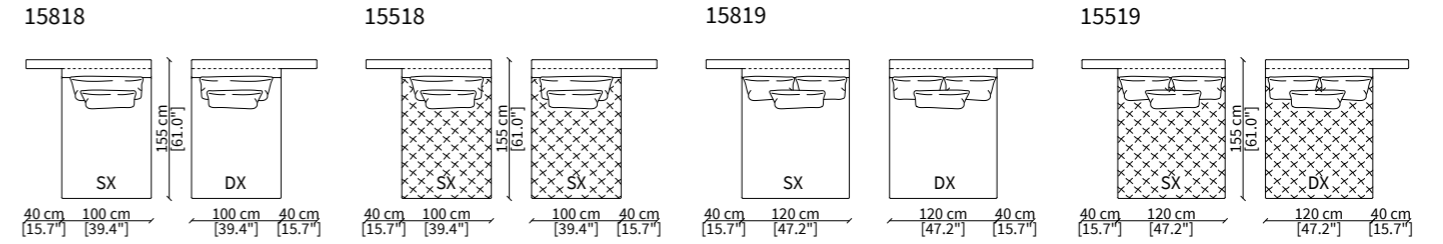

BRACCIOLO DAY LOW / ARMREST DAY LOW

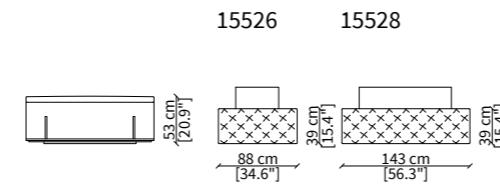

BRACCIOLO WOOD / ARMREST WOOD

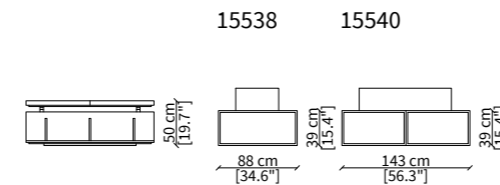

Dimensioni espresse in cm se non diversamente indicato.
L'Azienda si riserva il diritto di apportare modifiche ai modelli senza preavviso.
Tolleranza sulle misure indicate di +/- 2%.

Dimensions in centimeter if not differently indicated.
The Company reserves the right to change the models without any advance notice.
Tolerance on the given sizes +/- 2%.

MILLER SOFA
Design R&D Frigerio

DETTAGLI DEGLI ELEMENTI ANGOLO / DETAILS OF CORNER ELEMENTS

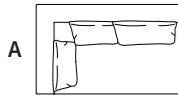

A angolo
corner

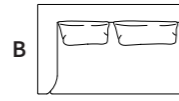

B bracciolo
armrest

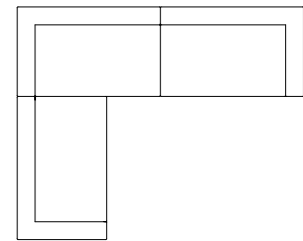

**CORRETTO /
CORRECT**

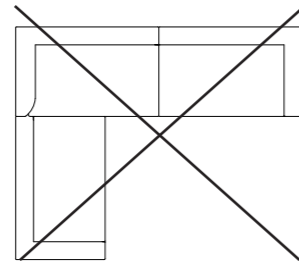

**ERRATO /
WRONG**

ESEMPI DI COMPOSIZIONE AD ANGOLO / EXAMPLES OF CORNER COMPOSITIONS

Le composizioni ad angolo possono essere così realizzate:
Corner composition can be built as follows:

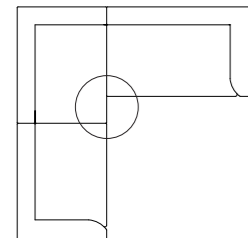

1. utilizzando gli elementi "terminali angolo", "dormeuses angolo",
"chaises longue angolo".

1. by using the elements "terminals corner", "dormeuses corner" or
"chaises longues corner".

15724 (Plain)
15424 (Quilt)

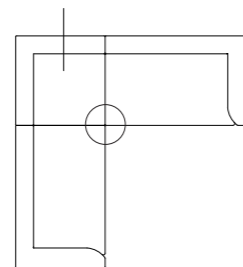

2. utilizzando l'angolo (art. **15724 Plain** e art. **15424 Quilt**) per un
allineamento preciso delle sedute.

2. by using the corner (art. **15724 Plain** and art. **15424 Quilt**) for a
perfect alignment of the seats.

Dimensioni espresse in cm se non diversamente indicato.
L'Azienda si riserva il diritto di apportare modifiche ai modelli senza preavviso.
Tolleranza sulle misure indicate di +/- 2%.

Dimensions in centimeter if not differently indicated.
The Company reserves the right to change the models without any advance notice.
Tolerance on the given sizes +/- 2%.

MILLER SOFA
Design R&D Frigerio

COMPOSIZIONE 1 / COMPOSITION 1

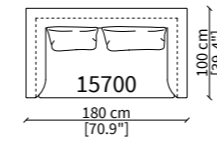

CODICI / CODES: **15700**

COMPOSIZIONE 2 / COMPOSITION 2

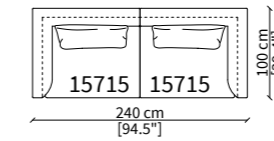

CODICI / CODES: **15715 x 2**

COMPOSIZIONE 3 / COMPOSITION 3

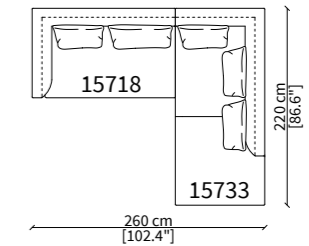

CODICI / CODES: **15718, 15733**

COMPOSIZIONE 4 / COMPOSITION 4

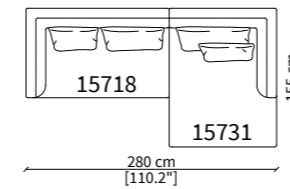

CODICI / CODES: **15718, 15731**

COMPOSIZIONE 5 / COMPOSITION 5

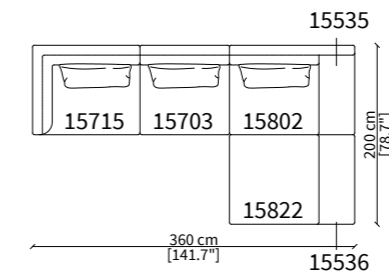

CODICI / CODES: **15715, 15703, 15802, 15535, 15536**

COMPOSIZIONE 6 / COMPOSITION 6

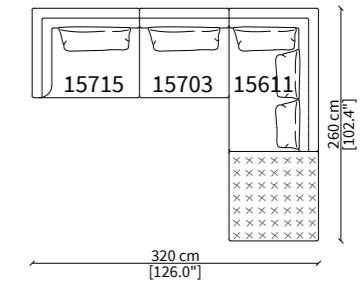

CODICI / CODES: **15715, 15703, 15611**

COMPOSIZIONE 7 / COMPOSITION 7

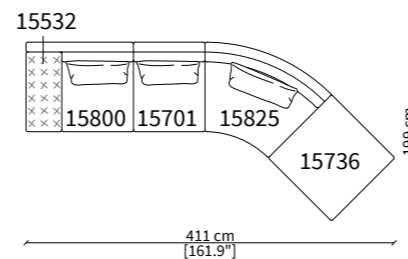

CODICI / CODES: **15532, 15800, 15701, 15825, 15736**

COMPOSIZIONE 8 / COMPOSITION 8

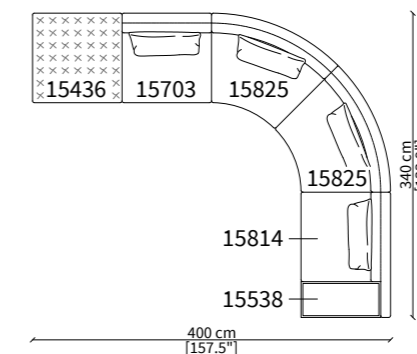

CODICI / CODES: **15436, 15703, 15825 x 2, 15814, 15538**

COMPOSIZIONE 9 / COMPOSITION 9

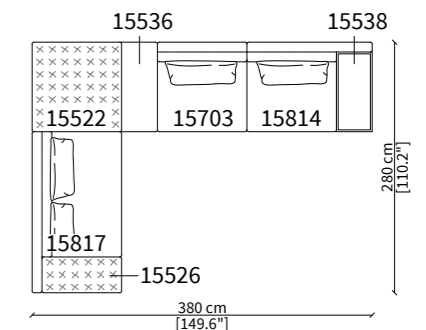

CODICI / CODES: **15526, 15817, 15522, 15536, 15703, 15814, 15538**

Dimensioni espresse in cm se non diversamente indicato.
L'Azienda si riserva il diritto di apportare modifiche ai modelli senza preavviso.
Tolleranza sulle misure indicate di +/- 2%.

Dimensions in centimeter if not differently indicated.
The Company reserves the right to change the models without any advance notice.
Tolerance on the given sizes +/- 2%.

MILLER DOUBLE FULL BACK SOFA

Design R&D Frigerio

MILLER DOUBLE FULL BACK / d. 110 cm

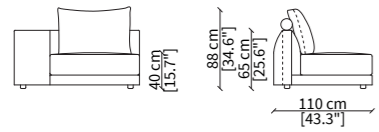

ELEMENTI CENTRALI / CENTRAL ELEMENTS

17000 17001 17005

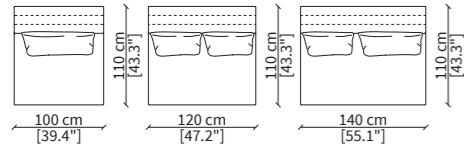

CHAISES LONGUE CENTRALI / CENTRAL CHAISES LONGUE

17002 17003

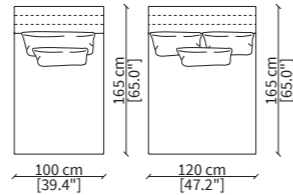

ELEMENTI TERMINALI TOP / TERMINAL TOP ELEMENTS

16800 16803

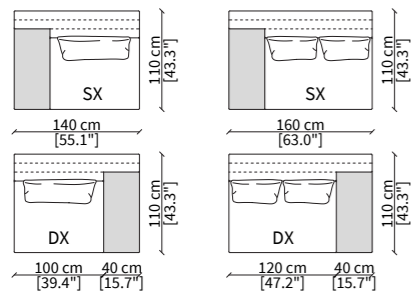

ELEMENTI TERMINALI OPEN / TERMINAL OPEN ELEMENTS

16900 16903

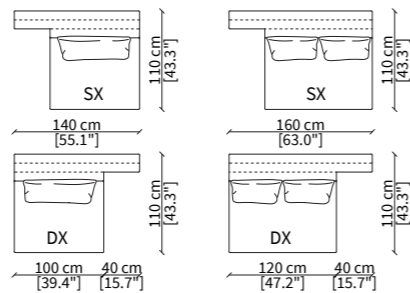

CHAISES LONGUE TOP

16806

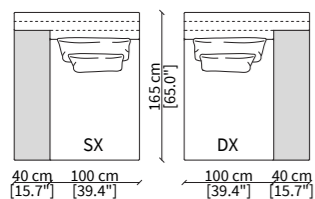

CHAISES LONGUE OPEN

16906

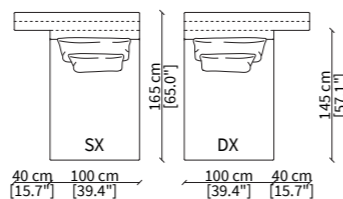

16809

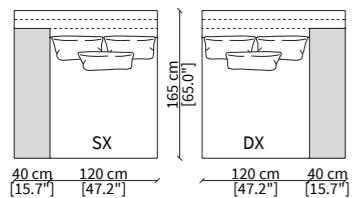

16909

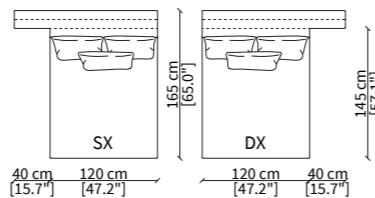

Dimensioni espresse in cm se non diversamente indicato.
L'Azienda si riserva il diritto di apportare modifiche ai modelli senza preavviso.
Tolleranza sulle misure indicate di +/- 2%.

Dimensions in centimeter if not differently indicated.
The Company reserves the right to change the models without any advance notice.
Tolerance on the given sizes +/- 2%.

MILLER DOUBLE FULL BACK SOFA

Design R&D Frigerio

MILLER DOUBLE FULL BACK ELEMENTI SEDUTA / SEAT ELEMENTS / d. 80 cm

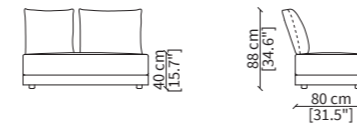

ELEMENTI SEDUTA / SEAT ELEMENTS

17100 17101 17102 17103

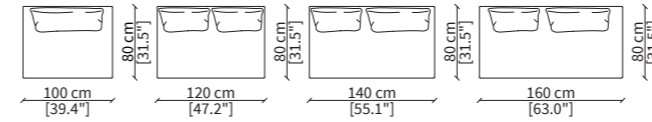

17200 17201 17202 17203

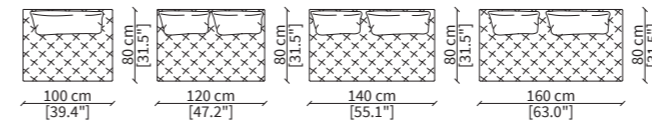

ELEMENTI SEDUTA CHAISE LONGUE / CHAISE LONGUE SEAT ELEMENTS

17104 17105

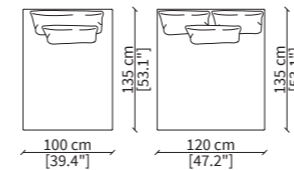

17204 17205

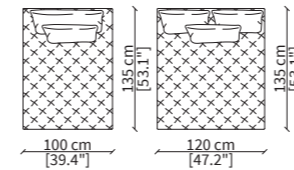

Dimensioni espresse in cm se non diversamente indicato.
L'Azienda si riserva il diritto di apportare modifiche ai modelli senza preavviso.
Tolleranza sulle misure indicate di +/- 2%.

Dimensions in centimeter if not differently indicated.
The Company reserves the right to change the models without any advance notice.
Tolerance on the given sizes +/- 2%.

MILLER DOUBLE SHAPED BACK SOFA

Design R&D Frigerio

MILLER DOUBLE SHAPED BACK / d. 110 cm

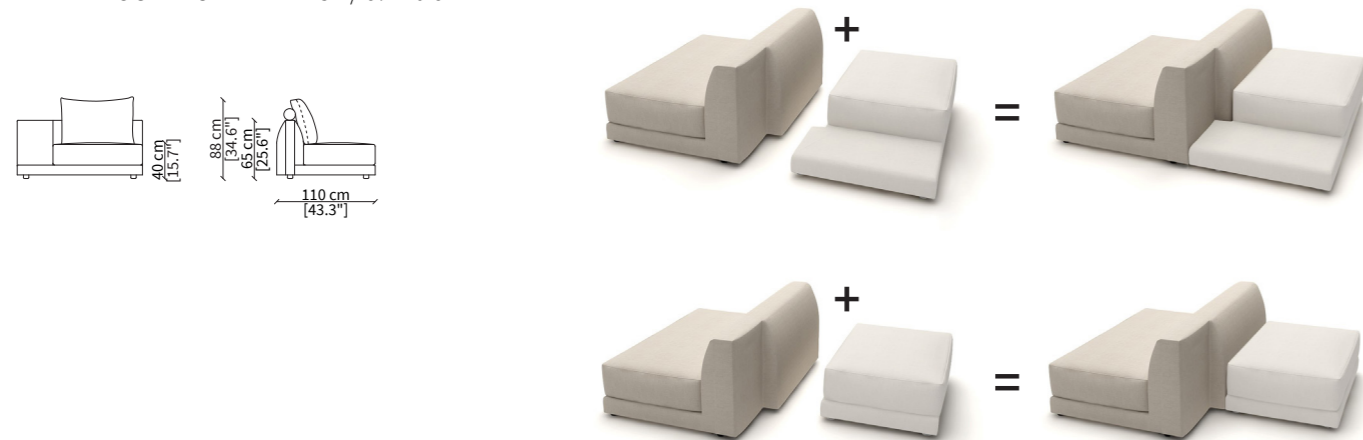

ELEMENTI TERMINALI TOP / TERMINAL TOP ELEMENTS

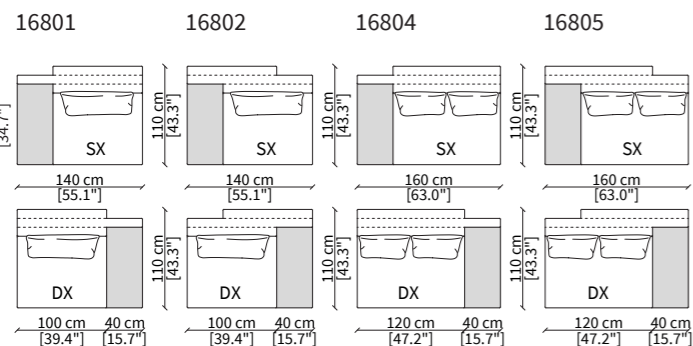

ELEMENTI TERMINALI OPEN / TERMINAL OPEN ELEMENTS

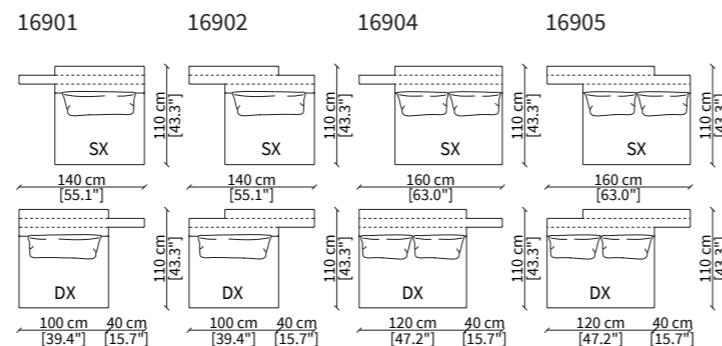

CHAISES LONGUE TOP

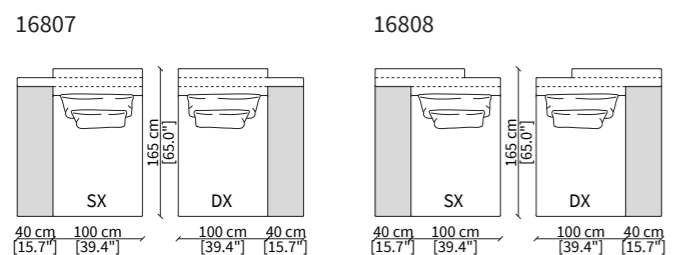

CHAISES LONGUE OPEN

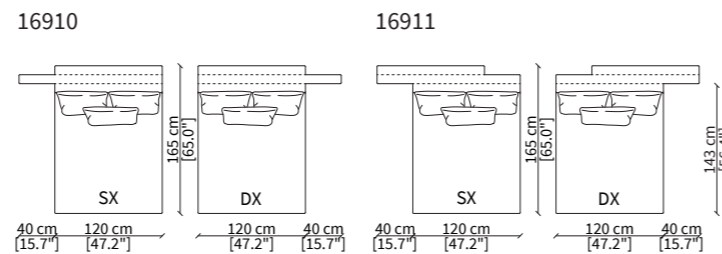
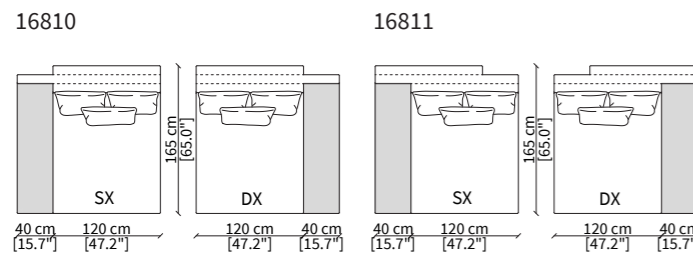
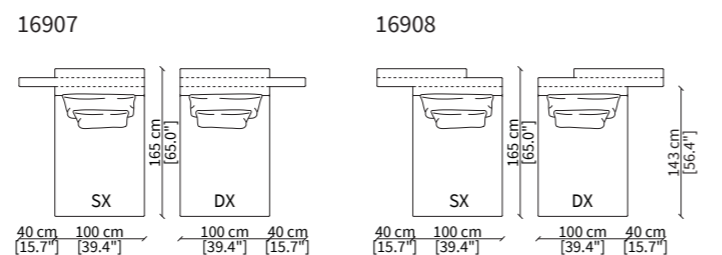

Dimensioni espresse in cm se non diversamente indicato.
L'Azienda si riserva il diritto di apportare modifiche ai modelli senza preavviso.
Tolleranza sulle misure indicate di +/- 2%.

Dimensions in centimeter if not differently indicated.
The Company reserves the right to change the models without any advance notice.
Tolerance on the given sizes +/- 2%.

MILLER DOUBLE SHAPED BACK SOFA

Design R&D Frigerio

MILLER DOUBLE SHAPED BACK ELEMENTI SEDUTA / SEAT ELEMENTS / d. 80 cm

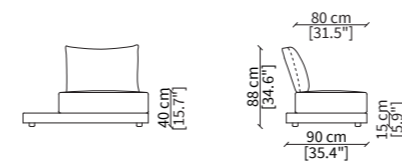

ELEMENTI SEDUTA TOP / SEAT ELEMENTS TOP

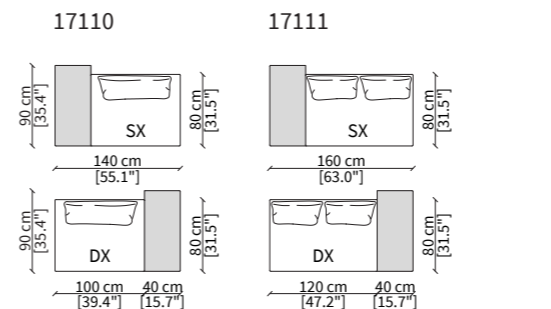

ELEMENTI SEDUTA CHAISE LONGUE TOP / CHAISE LONGUE SEAT ELEMENTS TOP

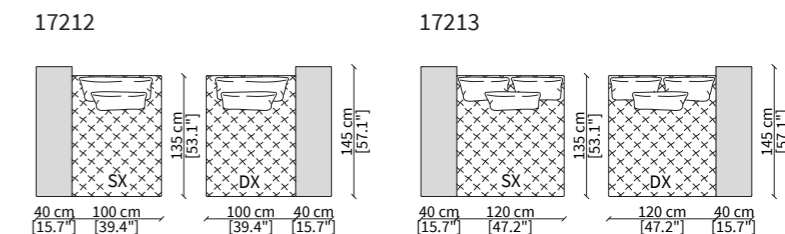
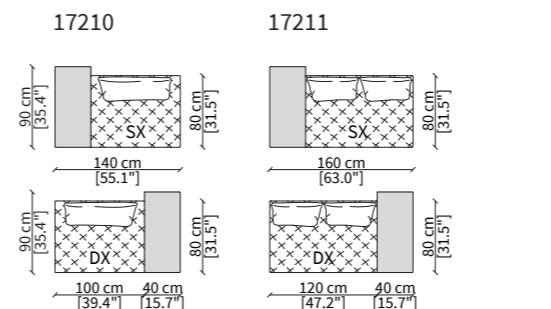
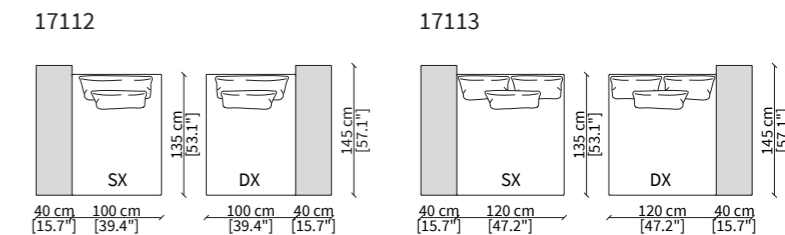

ELEMENTI SEDUTA / SEAT ELEMENTS

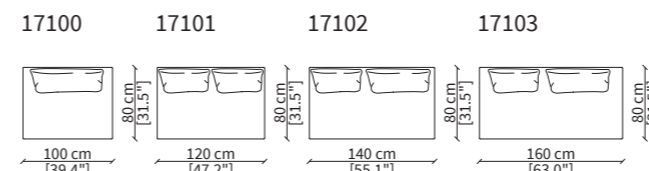

ELEMENTI SEDUTA CHAISE LONGUE / CHAISE LONGUE SEAT ELEMENTS

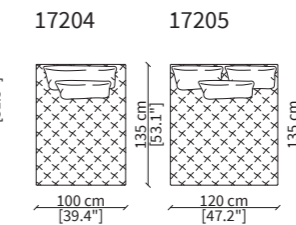
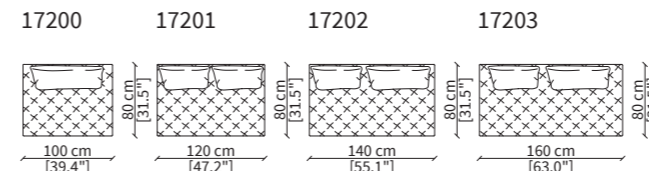
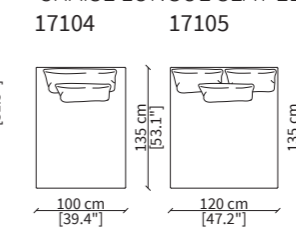

Dimensioni espresse in cm se non diversamente indicato.
L'Azienda si riserva il diritto di apportare modifiche ai modelli senza preavviso.
Tolleranza sulle misure indicate di +/- 2%.

Dimensions in centimeter if not differently indicated.
The Company reserves the right to change the models without any advance notice.
Tolerance on the given sizes +/- 2%.

MILLER DOUBLE SOFA

Design R&D Frigerio

MILLER DOUBLE ACCESSORI TOP E OPEN / TOP AND OPEN ACCESSORIES

ACCESSORI PER ELEMENTI TOP / ACCESSORIES FOR TOP ELEMENTS

VOLUME SOFT

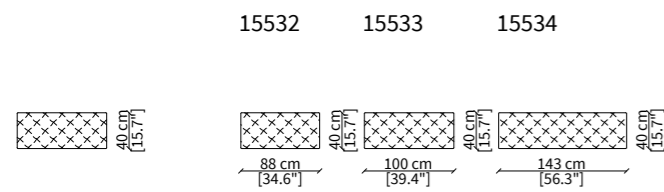

VOLUME PAD

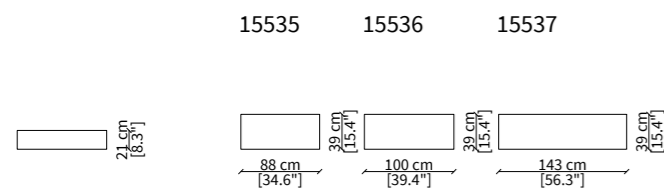

CABINET

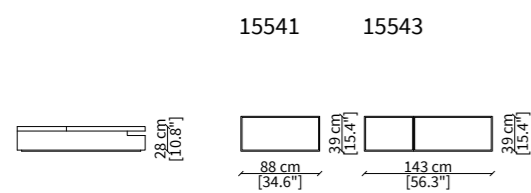

ACCESSORI PER ELEMENTI OPEN / ACCESSORIES FOR OPEN ELEMENTS

DAY LOW

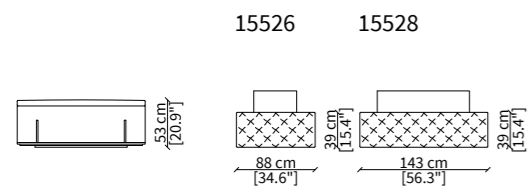

WOOD

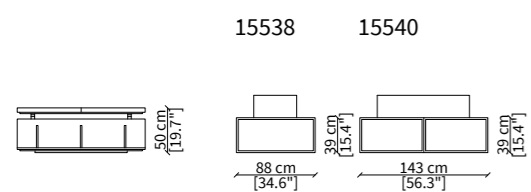

Dimensioni espresse in cm se non diversamente indicato.
L'Azienda si riserva il diritto di apportare modifiche ai modelli senza preavviso.
Tolleranza sulle misure indicate di +/- 2%.

Dimensions in centimeter if not differently indicated.
The Company reserves the right to change the models without any advance notice.
Tolerance on the given sizes +/- 2%.

MILLER DOUBLE SOFA

Design R&D Frigerio

MILLER DOUBLE ACCESSORI / ACCESSORIES

POUFS

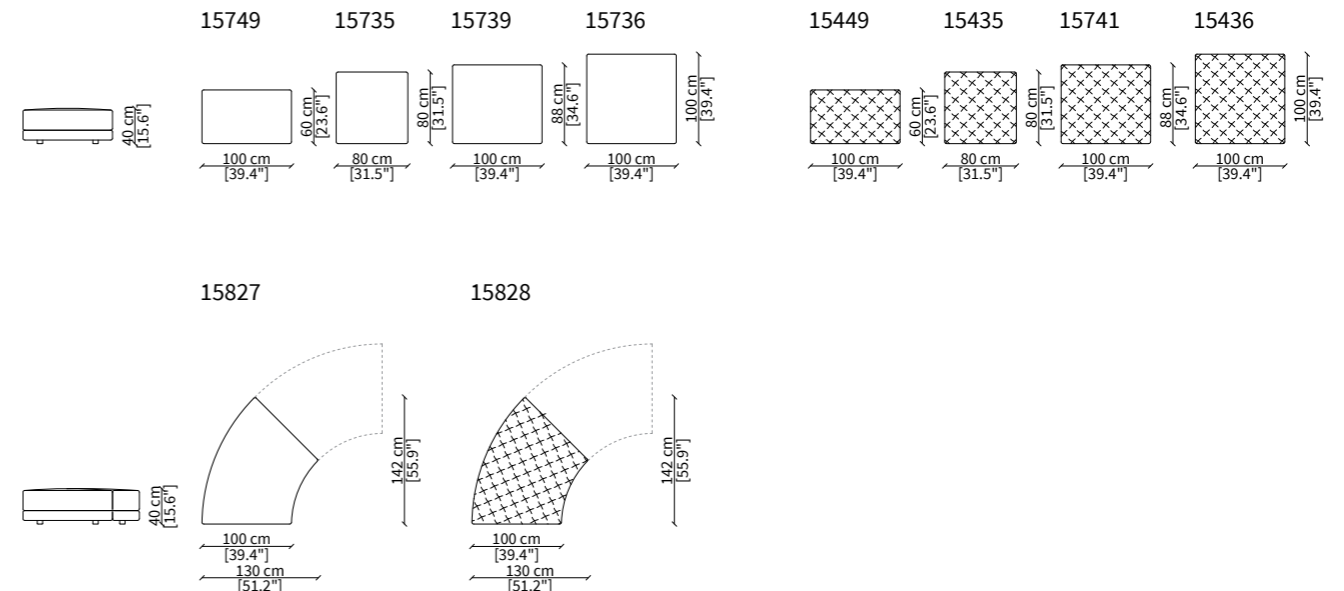

VOLUMI POUF / POUF VOLUMES

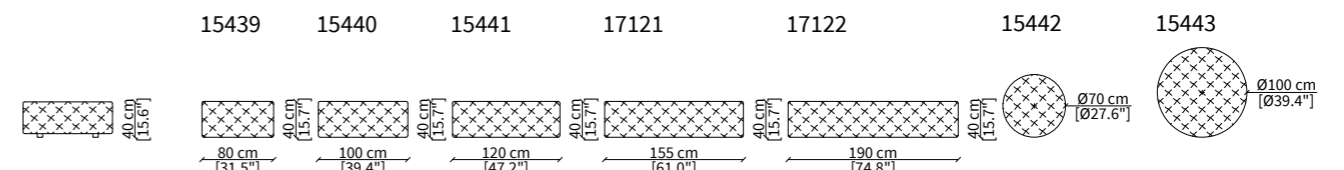

TAVOLINI / SMALL TABLES

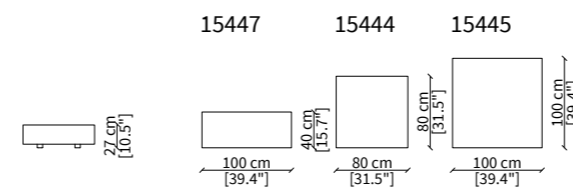

CUSCINI / CUSHIONS

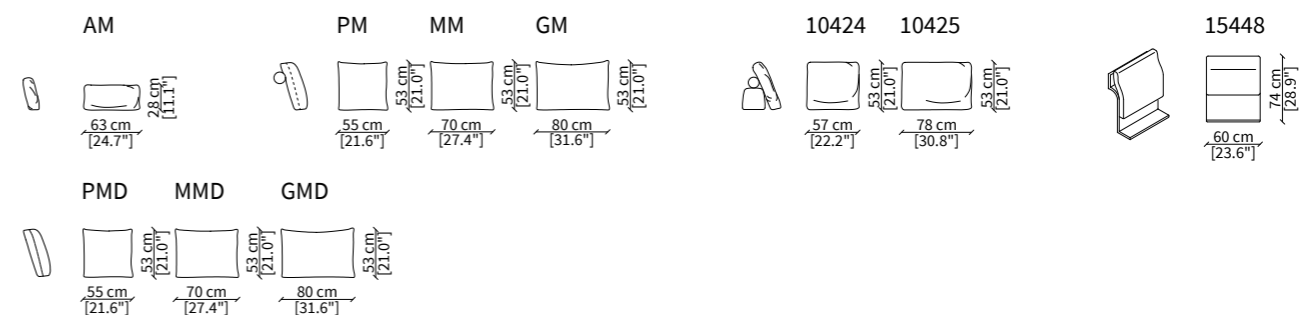

Dimensioni espresse in cm se non diversamente indicato.
L'Azienda si riserva il diritto di apportare modifiche ai modelli senza preavviso.
Tolleranza sulle misure indicate di +/- 2%.

Dimensions in centimeter if not differently indicated.
The Company reserves the right to change the models without any advance notice.
Tolerance on the given sizes +/- 2%.

MILLER DOUBLE SOFA Design R&D Frigerio

COMPOSIZIONE 1 / COMPOSITION 1

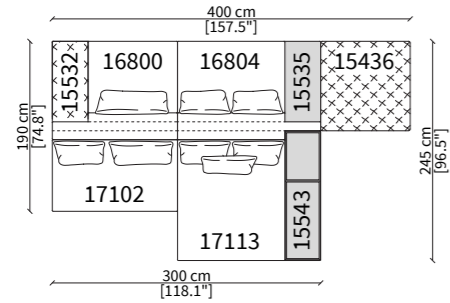

CODICI / CODES: **15532, 16800, 16804, 15535, 15436, 17102, 17113, 15543**

COMPOSIZIONE 2 / COMPOSITION 2

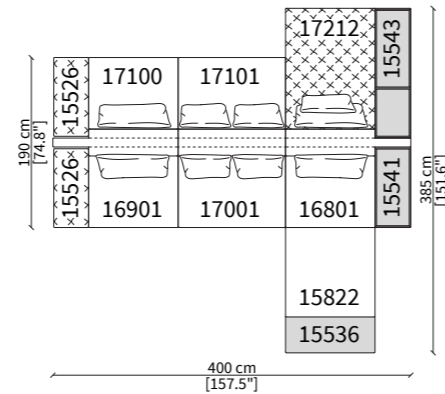

CODICI / CODES: **15526 x 2, 17100, 17101, 17212, 15543, 16901, 17001, 16801, 15541, 15822, 15536**

COMPOSIZIONE 5 / COMPOSITION 5

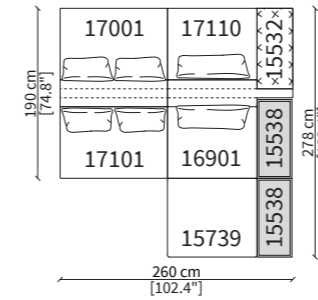

CODICI / CODES: **17001 17110, 17101, 16901, 15739, 15538 x 2, 15532**

COMPOSIZIONE 6 / COMPOSITION 6

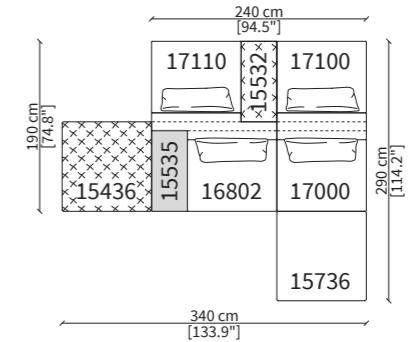

CODICI / CODES: **15436, 15535, 17110, 15532, 17100, 16802, 17000, 15736**

COMPOSIZIONE 3 / COMPOSITION 3

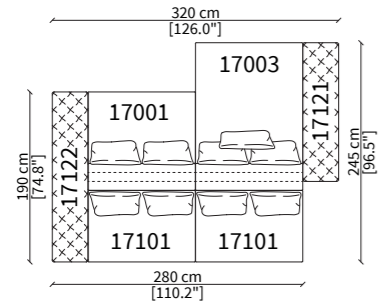

CODICI / CODES: **17122, 17001, 17003, 17121, 17101 x 2**

COMPOSIZIONE 4 / COMPOSITION 4

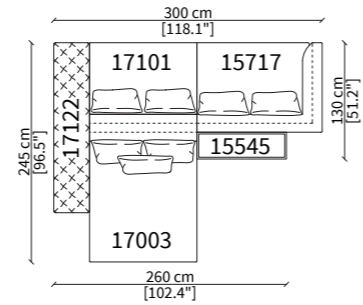

CODICI / CODES: **17122, 17101, 15717, 17003, 15545**

COMPOSIZIONE 7 / COMPOSITION 7

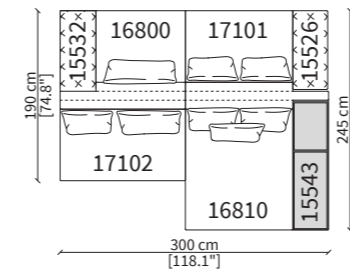

CODICI / CODES: **15532, 16800, 17101, 15526, 17102, 16810, 15543**

MILLER DOUBLE SOFA Design R&D Frigerio

Per la gamma completa di materiali è possibile consultare il nostro sito web www.frigerio.com
The full range of materials can be found on our website at www.frigerio.com.

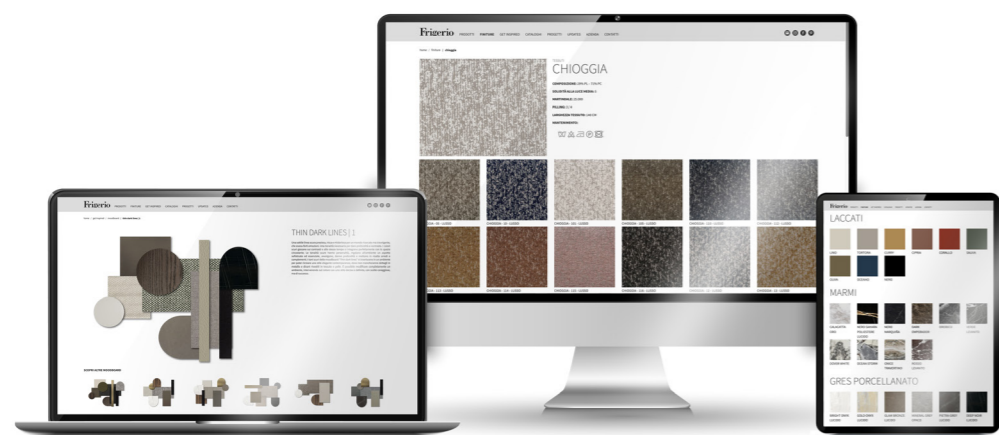

WWW.FRIGERIO.COM

Frigerio

Via Sant'Agata 63
22066 Mariano Comense (CO) - Italy
Tel. +39 031 5481225
info@frigerio.com
www.frigerio.com