

Frigerio

HORIZON SOFA

Design Christophe Pillet

Horizon è il nuovo divano componibile modulare su pianale che interpreta con il tratto disinvolto di Pillet la qualità e la cura di Frigerio. Una proposta che riflette l'abitare contemporaneo e il ruolo che oggi è richiesto al divano: un divano relax, elemento protagonista dello spazio sempre più versatile e fluido nell'uso e nelle funzioni. Un programma molto ampio per un divano di design con soluzioni lineari, angolari, più o meno complesse, con elementi trapezoidali asimmetrici, elementi curvi e con la possibilità di avere un divano con una seduta profonda. Sono disponibili due profondità di seduta, per assecondare stili di vita eterogenei ed esigenze funzionali e spaziali in ambito residenziale come contract. Il pianale su cui poggiano gli schienali e i braccioli è sospeso e rivestito in tessuto o in pelle, ad accentuarne il carattere sofisticato. Per il massimo comfort di seduta, Pillet propone in base alla profondità diverse tipologie di braccioli che si armonizzano al design del prodotto. Si aggiunge inoltre la possibilità di inserire nella composizione diversi accessori, posizionabili sia come elementi centrali che terminali, che aumentano la funzionalità del divano, diventando un piano d'appoggio o volumi imbottiti per creare una nuova tipologia di bracciolo.

Horizon is the new modular sectional sofa on platform which interprets the quality and care of Frigerio with Pillet's nonchalant style. The proposal reflects the contemporary living and the position, which is today required to the sofa: a relax sofa, leading character of the space more and more versatile and fluid in the use and functions. A wide range of for a design sofa with linear, corner, more or less complex solutions, with asymmetrical trapezoidal elements, curved elements and with the possibility to have a deep seat sofa. There are two seat depths available to suit heterogeneous lifestyles and functional and spatial requirements in both residential and contract settings. The platform on which the backrests and armrests are fitted is covered in fabric or leather to accentuate its sophisticated character. For maximum seating comfort, Pillet proposes different kind of armrests depending on the depth harmonizing with the product's design. There is also the possibility to insert in the composition several accessories, which can be positioned both as central and terminal elements, which increase the functionality of the sofa, becoming a support surface, or padded volumes to create a new kind of armrest.

Base: legno multistrato imbottito in poliuretano espanso indeformabile rivestito in tessuto protettivo accoppiato. Il modello è dotato di piedini centrali di sicurezza.

Schienali: legno multistrato imbottito in poliuretano espanso indeformabile rivestito in tessuto protettivo accoppiato, con fissaggio a baionetta.

Braccioli: legno multistrato imbottito in poliuretano espanso indeformabile rivestito in tessuto protettivo accoppiato, con fissaggio a baionetta.

Cuscini seduta: poliuretano espanso indeformabile.

Cuscini schienale: piuma d'oca (Assopiuma).

Piedini: metallo color Brunito. Su richiesta disponibili in metallo colore Greige Sablé, color Nero Sablé, color Sabbia Sablé o color Titanio.

Rivestimento: sfoderabile in tessuto, fisso in pelle, parzialmente sfoderabile nella combinazione pelle e tessuto (base in pelle non sfoderabile; sedute, schienali, braccioli e cuscini in tessuto sfoderabile).

ACCESSORI:

| **server:** elemento fissato alla base con struttura in metallo color Brunito e top in Marmo.

VERSIONE HORIZON MEDIUM: profondità 97 cm.

VERSIONE HORIZON LARGE: profondità 107 cm con bracciolo lungo oppure con bracciolo corto.

Base: plywood padded with non-deformable polyurethane foam covered with doubled protective fabric. The model is provided with central security feet.

Backrests: plywood padded with non-deformable polyurethane foam covered with doubled protective fabric, with bayonet fastening.

Armrests: plywood padded with non-deformable polyurethane foam covered with doubled protective fabric, with bayonet fastening.

Seat cushions: non-deformable polyurethane foam.

Back cushions: goose down (Assopiuma).

Feet: metal Burnished colour. On demand available in metal colour Greige Sablé, colour Black Sablé, colour Sand Sablé or colour Titanium.

Cover: removable in fabric, fix in leather, partially removable in the combination leather and fabric (base in fix leather; seat, backrests, armrests, and small cushions in removable fabric).

ACCESSORIES:

| **server:** element fixed to the base with structure in metal colour Burnished and top in Marble.

VERSION HORIZON MEDIUM: depth 97 cm.

VERSION HORIZON LARGE: depth 107 cm with either long or short armrest.



HORIZON MEDIUM (97 CM / [38.2"])



Divani ed elementi componibili con versione classica del bracciolo, che è profondo come il divano (97 cm).

Sofas and elements for composition with a classic armrest version, which is as deep as the sofa (97 cm).



HORIZON LARGE (107 CM / [42.1"])



Bracciolo lungo (107 cm) /
long armrest (107 cm)

Bracciolo corto (85 cm) /
short armrest (85 cm)

Divani ed elementi componibili con versione classica del bracciolo, che può essere profondo come il divano (107 cm), o più corto del divano (85 cm).

Sofas and elements for composition with a classic armrest version, which can be as deep as the sofa (107 cm), or shorter than the sofa (85 cm).



SERVER



Server con struttura in metallo e piano in legno o marmo, posizionabile liberamente fissandolo alla base del divano tramite morsetto.

Server with metal frame and wooden or marble top, freely positionable by fixing it to the base of the sofa with a clamp.



HORIZON MEDIUM ELEMENTI TOP / TOP ELEMENTS



Elementi con struttura avente top imbottito, appoggio per **Volume Soft** e **Volume Wood**.

Elements with structure with upholstered top, support for **Volume Soft** and **Volume Wood**.

Struttura: legno multistrato imbottito in poliuretano espanso indeformabile.

Rivestimento: sfoderabile in tessuto, fisso in pelle.

Structure: plywood padded with non-deformable polyurethane foam.

Cover: removable in fabric, fix in leather.

Struttura: legno multistrato, con cassetto frontale disponibile in diverse colorazioni.

Structure: plywood, with front drawer available in different colours.

Profondità 97 cm
Depth 97 cm

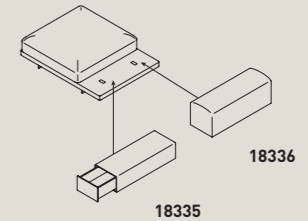
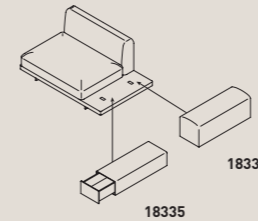

HORIZON LARGE ELEMENTI TOP / TOP ELEMENTS



Elementi con struttura avente top imbottito, appoggio per **Volume Soft** e **Volume Wood**.

Elements with structure with upholstered top, support for **Volume Soft** and **Volume Wood**.

Struttura: legno multistrato imbottito in poliuretano espanso indeformabile.

Rivestimento: sfoderabile in tessuto, fisso in pelle.

Structure: plywood padded with non-deformable polyurethane foam.

Cover: removable in fabric, fix in leather.

Struttura: legno multistrato, con cassetto frontale disponibile in diverse colorazioni.

Structure: plywood, with front drawer available in different colours.

Profondità 107 cm
Depth 107 cm

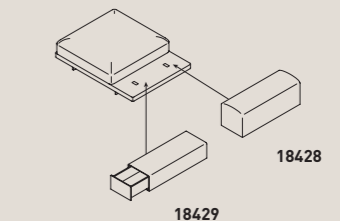
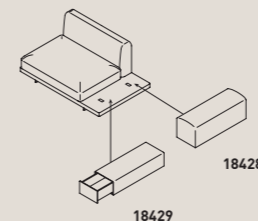

HORIZON MEDIUM SOFA

Design Christophe Pillet

HORIZON MEDIUM / d. 97 cm

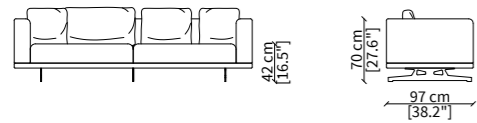

DIVANI / SOFAS

18300 18301 18302

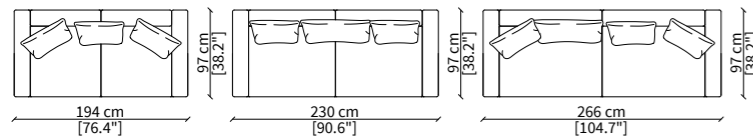

ELEMENTI TERMINALI / TERMINAL ELEMENTS

18303 18304 18305 18306 18307 18308

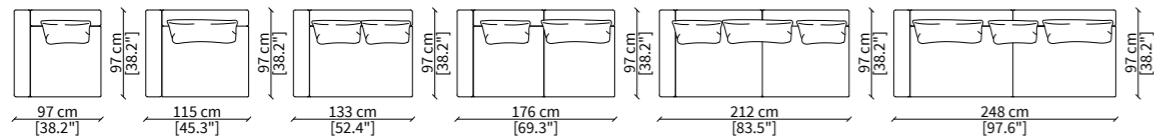

ELEMENTI CENTRALI / CENTRAL ELEMENTS

18311 18312 18313 18314 18315

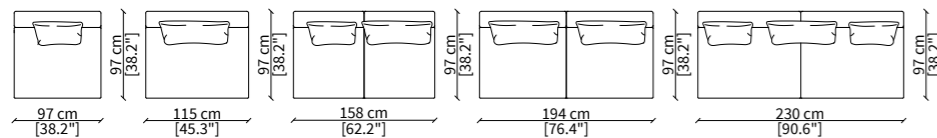

ELEMENTI DORMEUSE / DORMEUSE ELEMENTS

18340

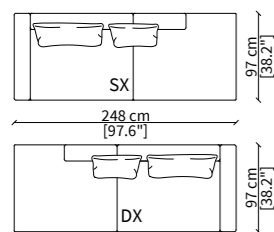

ELEMENTI DORMEUSE POUF / DORMEUSE POUF ELEMENTS

18309

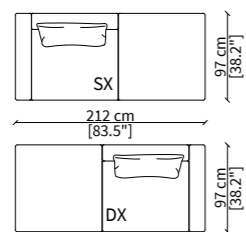

18310

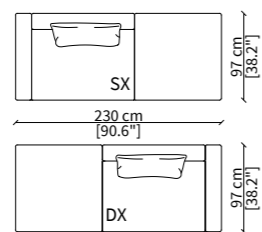

ELEMENTI CENTRALI DORMEUSE / CENTRAL DORMEUSE ELEMENTS

18316

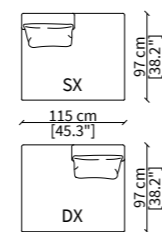

18317

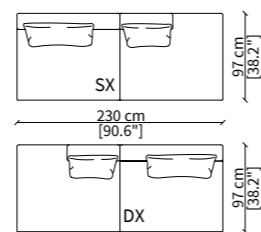

Dimensioni espresse in cm se non diversamente indicato.
L'Azienda si riserva il diritto di apportare modifiche ai modelli senza preavviso.
Tolleranza sulle misure indicate di +/- 2%.

Dimensions in centimeter if not differently indicated.
The Company reserves the right to change the models without any advance notice.
Tolerance on the given sizes +/- 2%.

HORIZON MEDIUM SOFA

Design Christophe Pillet

CHAIRES LONGUE

18318

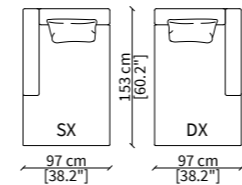

18319

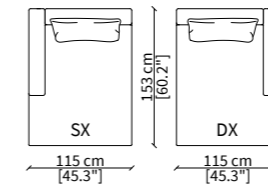

CHAIRES LONGUE CENTRALI / CENTRAL CHAIRES LONGUE

18320

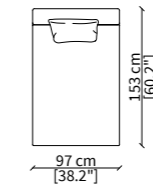

18321

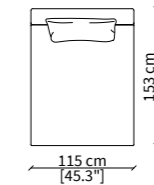

ELEMENTI TERMINALI LONGUE / TERMINAL LONGUE ELEMENTS

18341

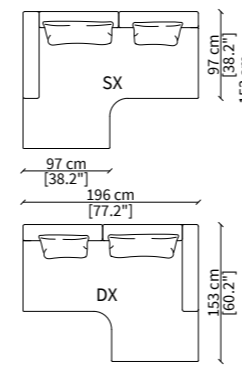

18322

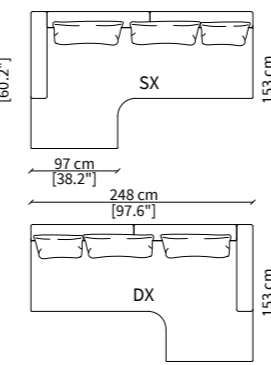

ELEMENTO DORMEUSE GEOMETRICO / GEOMETRICAL DORMEUSE ELEMENT

18339

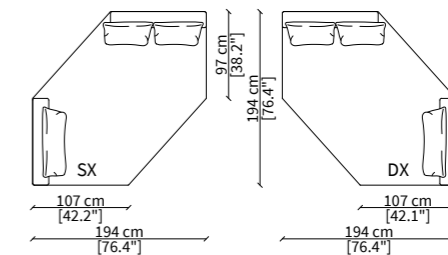

ELEMENTO ANGOLO / CORNER ELEMENT

18324

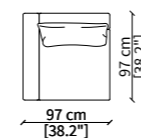

ELEMENTI ANGOLO CURVI / CURVED CORNER ELEMENTS

18326

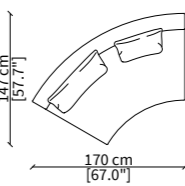

18327

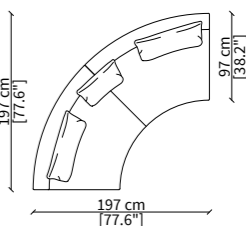

POUFS

18337

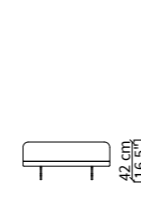

18430

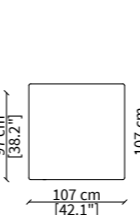

ELEMENTO POUF GEOMETRICO / GEOMETRICAL POUF ELEMENT

18338

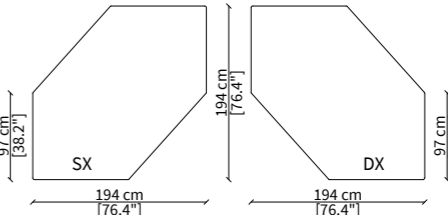

Dimensioni espresse in cm se non diversamente indicato.
L'Azienda si riserva il diritto di apportare modifiche ai modelli senza preavviso.
Tolleranza sulle misure indicate di +/- 2%.

Dimensions in centimeter if not differently indicated.
The Company reserves the right to change the models without any advance notice.
Tolerance on the given sizes +/- 2%.

HORIZON MEDIUM SOFA Design Christophe Pillet

HORIZON MEDIUM TOP



ELEMENTI TERMINALI TOP / TERMINAL TOP ELEMENTS

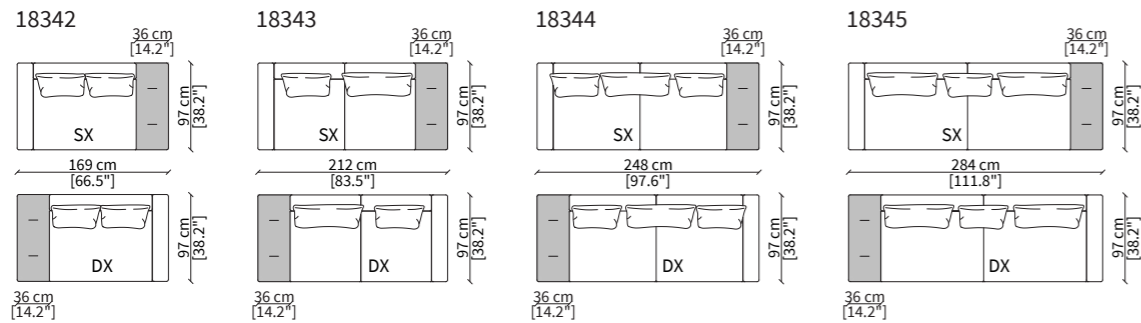

ELEMENTI CENTRALI TOP / CENTRAL TOP ELEMENTS

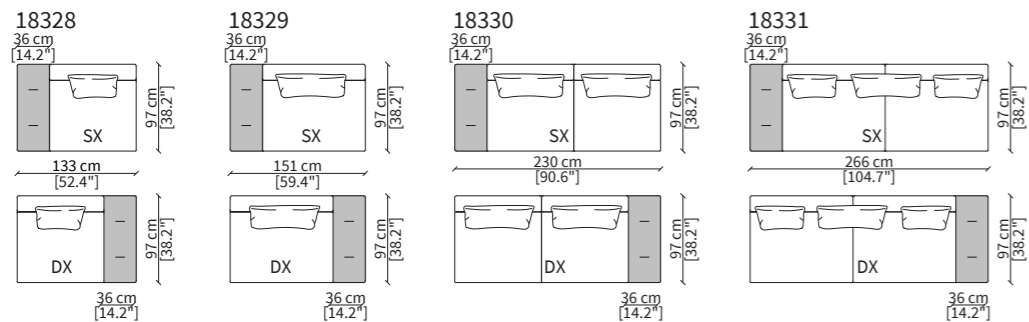

ELEMENTI CENTRALI DORMEUSE POUF TOP / CENTRAL DORMEUSE POUF TOP ELEMENTS

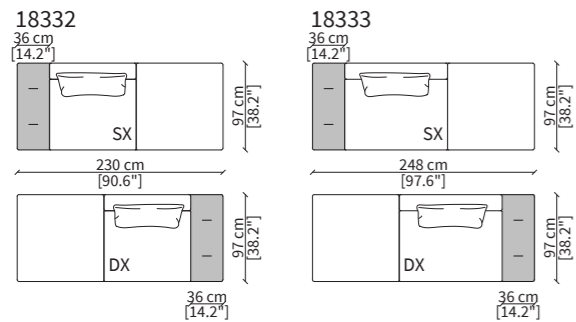

ELEMENTO POUF TOP / POUF TOP ELEMENT

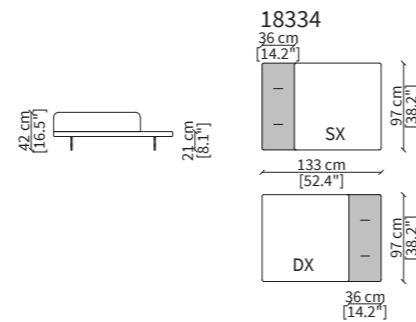

Dimensioni espresse in cm se non diversamente indicato.
L'Azienda si riserva il diritto di apportare modifiche ai modelli senza preavviso.
Tolleranza sulle misure indicate di +/- 2%.

Dimensions in centimeter if not differently indicated.
The Company reserves the right to change the models without any advance notice.
Tolerance on the given sizes +/- 2%.

HORIZON MEDIUM SOFA Design Christophe Pillet

SERVER



POGGIA-TESTA / HEAD-REST

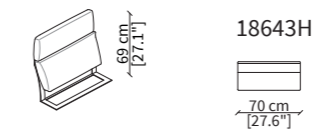

VOLUMI / VOLUMES

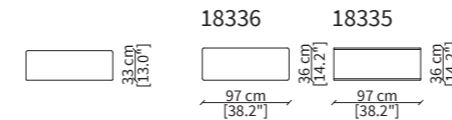

ESEMPI DI COMPOSIZIONE AD ANGOLO / EXAMPLES OF CORNER COMPOSITIONS

Le composizioni ad angolo possono essere così realizzate:
Corner composition can be built as follows:

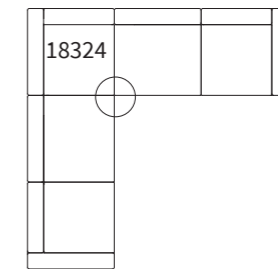
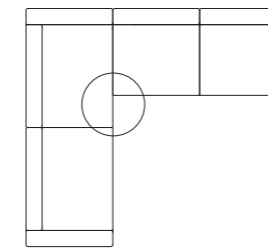

1. accostando tra loro gli elementi.
Suggeriamo l'aggiunta di un cuscino schienale per maggior comfort.

2. utilizzando l'angolo (art. **18324**) per un allineamento preciso delle sedute.

1. by combining the elements.
We recommend adding an extra back cushion for a better comfort.

2. by using the corner (art. **18324**) for a perfect alignment of the seats.

ESEMPI DI COMPOSIZIONE CON DORMEUSE GEOMETRICA / EXAMPLES OF COMPOSITION WITH GEOMETRICAL DORMEUSE

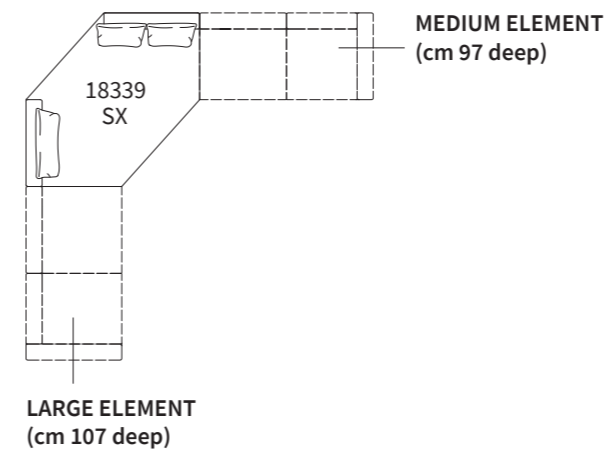

La dormeuse geometrica viene usata come elemento di connessione tra elementi Horizon Medium (che devono essere usati sul lato profondo cm 97) ed elementi Horizon Large (che devono essere usati sul lato profondo cm 107).

The geometrical dormeuse is used as connection between Horizon Medium elements (to be joined on the side cm 97 deep) and Horizon Large elements (to be joined on the side cm 107 deep).

Dimensioni espresse in cm se non diversamente indicato.
L'Azienda si riserva il diritto di apportare modifiche ai modelli senza preavviso.
Tolleranza sulle misure indicate di +/- 2%.

Dimensions in centimeter if not differently indicated.
The Company reserves the right to change the models without any advance notice.
Tolerance on the given sizes +/- 2%.

HORIZON MEDIUM SOFA Design Christophe Pillet

COMPOSIZIONE 1 / COMPOSITION 1

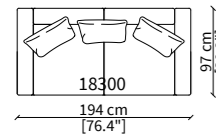

CODICI / CODES: **18300**

COMPOSIZIONE 2 / COMPOSITION 2

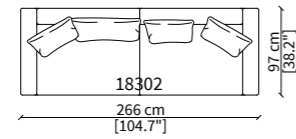

CODICI / CODES: **18302**

COMPOSIZIONE 3 / COMPOSITION 3

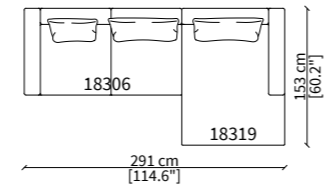

CODICI / CODES: **18306, 18319**

COMPOSIZIONE 4 / COMPOSITION 4

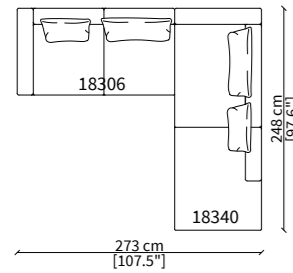

CODICI / CODES: **18306, 18340**

COMPOSIZIONE 5 / COMPOSITION 5

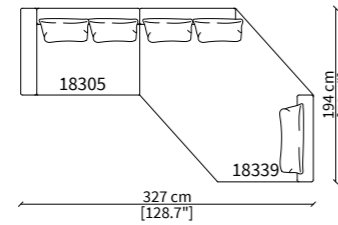

CODICI / CODES: **18305, 18339**

COMPOSIZIONE 6 / COMPOSITION 6

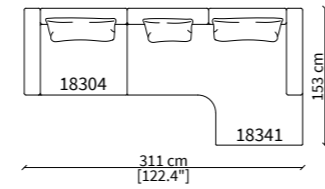

CODICI / CODES: **18304, 18341**

COMPOSIZIONE 7 / COMPOSITION 7

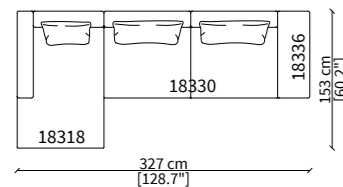

CODICI / CODES: **18318, 18330, 18336**

COMPOSIZIONE 8 / COMPOSITION 8

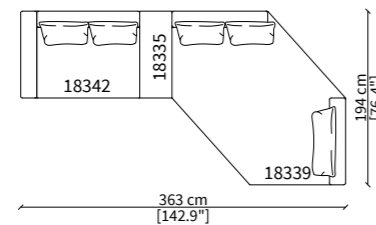

CODICI / CODES: **18342, 18335, 18339**

COMPOSIZIONE 9 / COMPOSITION 9

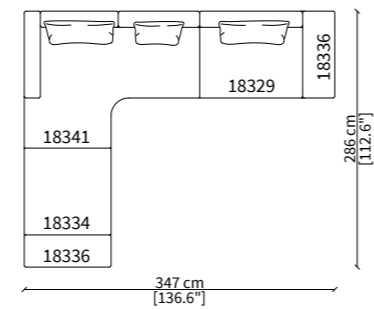

CODICI / CODES: **18336, 18334, 18341, 18329**

Dimensioni espresse in cm se non diversamente indicato.
L'Azienda si riserva il diritto di apportare modifiche ai modelli senza preavviso.
Tolleranza sulle misure indicate di +/- 2%.

Dimensions in centimeter if not differently indicated.
The Company reserves the right to change the models without any advance notice.
Tolerance on the given sizes +/- 2%.

HORIZON MEDIUM SOFA Design Christophe Pillet

COMPOSIZIONE 10 / COMPOSITION 10

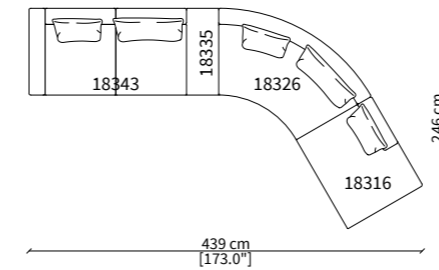

CODICI / CODES: **18343, 18335, 18326, 18316**

COMPOSIZIONE 11 / COMPOSITION 11

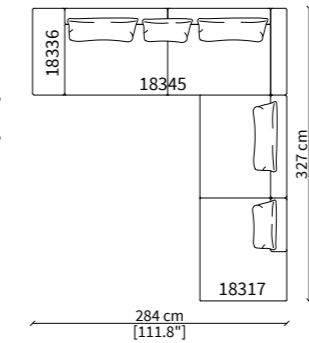

CODICI / CODES: **18336, 18345, 18317**

COMPOSIZIONE 12 / COMPOSITION 12

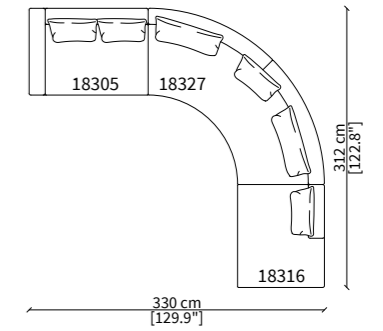

CODICI / CODES: **18305, 18327, 18316**

Dimensioni espresse in cm se non diversamente indicato.
L'Azienda si riserva il diritto di apportare modifiche ai modelli senza preavviso.
Tolleranza sulle misure indicate di +/- 2%.

Dimensions in centimeter if not differently indicated.
The Company reserves the right to change the models without any advance notice.
Tolerance on the given sizes +/- 2%.

HORIZON LARGE SOFA

Design Christophe Pillet

HORIZON LARGE / d. 107 cm
BRACCIOLLO LUNGO / LONG ARMREST / d. 107 cm

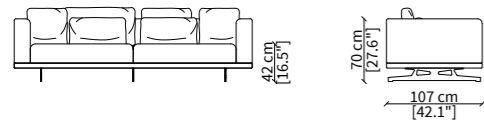

HORIZON LARGE / d. 107 cm
BRACCIOLLO CORTO / SHORT ARMREST / d. 85 cm

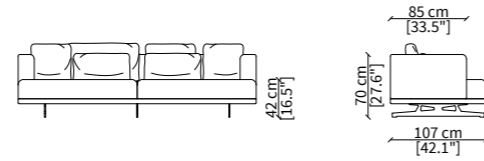

DIVANI CON BRACCIOLLO LUNGO / SOFAS WITH LONG ARMREST

18400 18401

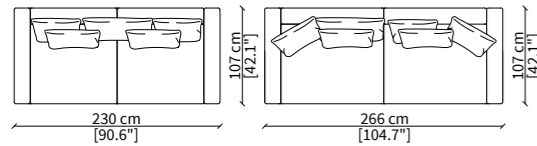

DIVANI CON BRACCIOLLO CORTO / SOFAS WITH SHORT ARMREST

18500 18501

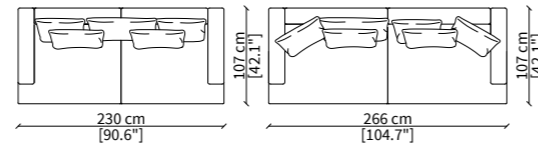

ELEMENTI TERMINALI CON BRACCIOLLO LUNGO / TERMINAL ELEMENTS WITH LONG ARMREST

18402 18403 18435 18404 18405

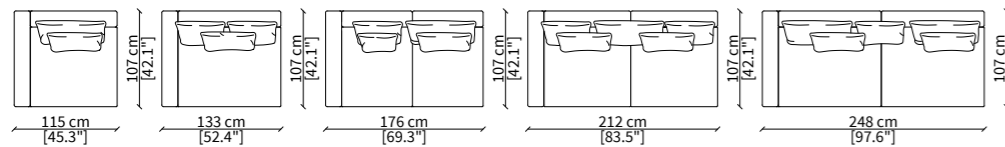

ELEMENTI TERMINALI CON BRACCIOLLO CORTO / TERMINAL ELEMENTS WITH SHORT ARMREST

18502 18503 18535 18504 18505

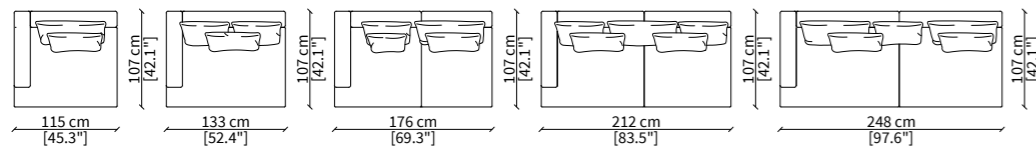

ELEMENTI CENTRALI / CENTRAL ELEMENTS

18408 18409 18410 18411

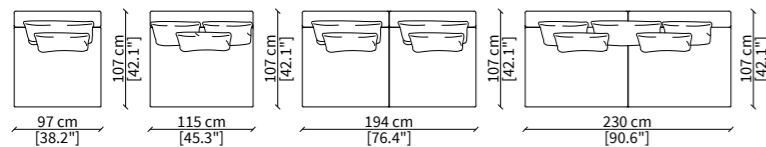

Dimensioni espresse in cm se non diversamente indicato.
L'Azienda si riserva il diritto di apportare modifiche ai modelli senza preavviso.
Tolleranza sulle misure indicate di +/- 2%.

Dimensions in centimeter if not differently indicated.
The Company reserves the right to change the models without any advance notice.
Tolerance on the given sizes +/- 2%.

HORIZON LARGE SOFA

Design Christophe Pillet

ELEMENTO DORMEUSE CON BRACCIOLLO LUNGO /
DORMEUSE ELEMENT WITH LONG ARMREST
18434

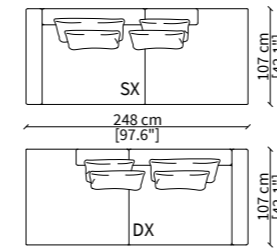

ELEMENTO DORMEUSE CON BRACCIOLLO CORTO /
DORMEUSE ELEMENT WITH SHORT ARMREST
18534

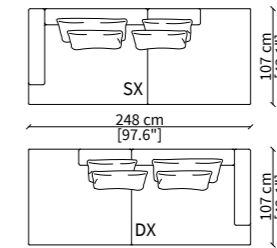

DORMEUSES POUF CON BRACCIOLLO LUNGO /
DORMEUSES WITH LONG ARMREST

18406 18407

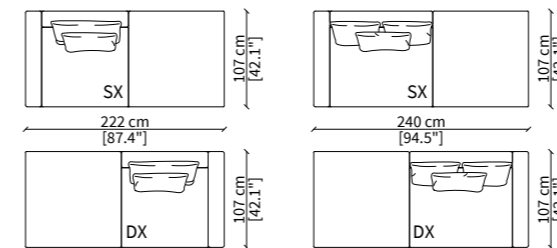

DORMEUSES POUF CON BRACCIOLLO CORTO /
DORMEUSES WITH SHORT ARMREST

18506 18507

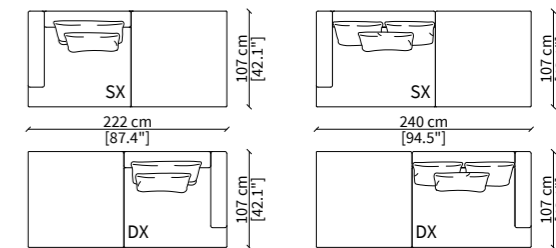

ELEMENTI DORMEUSE CENTRALI / CENTRAL DORMEUSE ELEMENTS

18412 18413

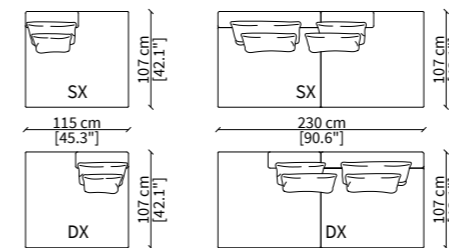

CHAISES LONGUE

18414 18415

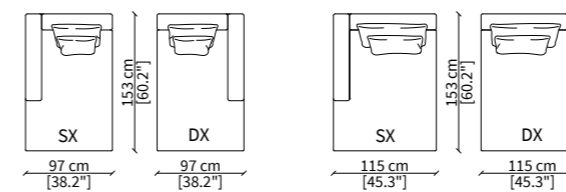

CHAISES LONGUE CENTRALI / CENTRAL CHAISES LONGUE

18416 18417

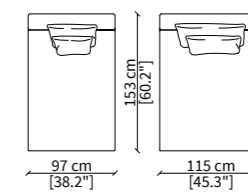

Dimensioni espresse in cm se non diversamente indicato.
L'Azienda si riserva il diritto di apportare modifiche ai modelli senza preavviso.
Tolleranza sulle misure indicate di +/- 2%.

Dimensions in centimeter if not differently indicated.
The Company reserves the right to change the models without any advance notice.
Tolerance on the given sizes +/- 2%.

HORIZON LARGE SOFA Design Christophe Pillet

ELEMENTI TERMINALI LONGUE / TERMINAL LONGUE ELEMENTS

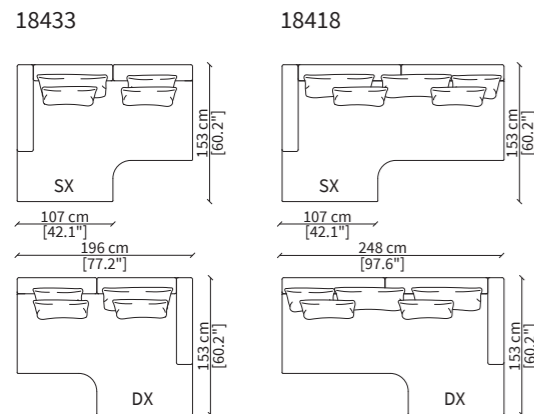

ELEMENTO DORMEUSE GEOMETRICO / GEOMETRICAL DORMEUSE ELEMENT

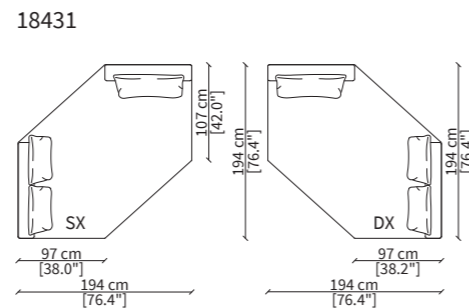

ELEMENTO ANGOLO / CORNER ELEMENT

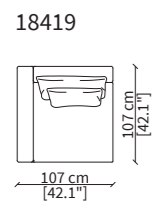

ELEMENTI ANGOLO CURVI / CURVED CORNER ELEMENTS

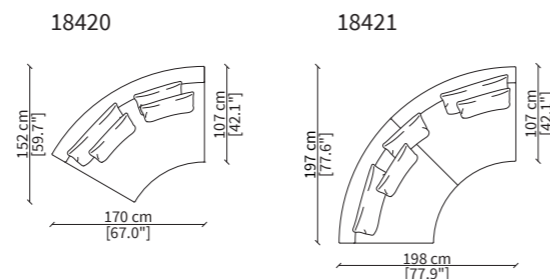

POUFS

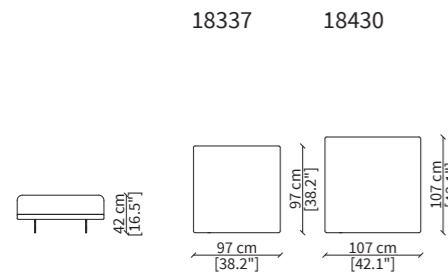

ELEMENTO POUF GEOMETRICO / GEOMETRICAL POUF ELEMENT

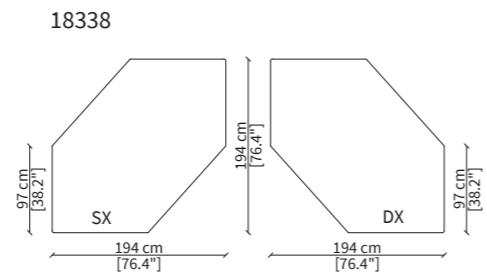

Dimensioni espresse in cm se non diversamente indicato.
L'Azienda si riserva il diritto di apportare modifiche ai modelli senza preavviso.
Tolleranza sulle misure indicate di +/- 2%.

Dimensions in centimeter if not differently indicated.
The Company reserves the right to change the models without any advance notice.
Tolerance on the given sizes +/- 2%.

HORIZON LARGE SOFA Design Christophe Pillet

HORIZON LARGE TOP



ELEMENTI TERMINALI TOP CON BRACCIOLO LUNGO / TERMINAL TOP ELEMENTS WITH LONG ARMREST

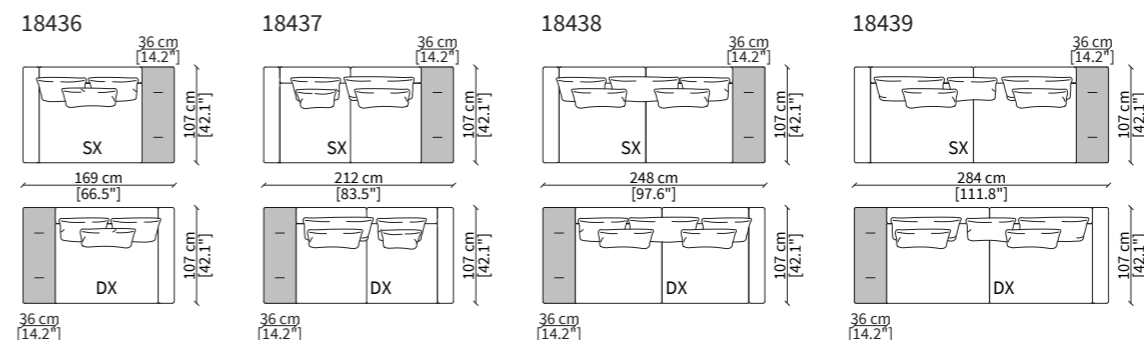

ELEMENTI TERMINALI TOP CON BRACCIOLO CORTO / TERMINAL TOP ELEMENTS WITH SHORT ARMREST

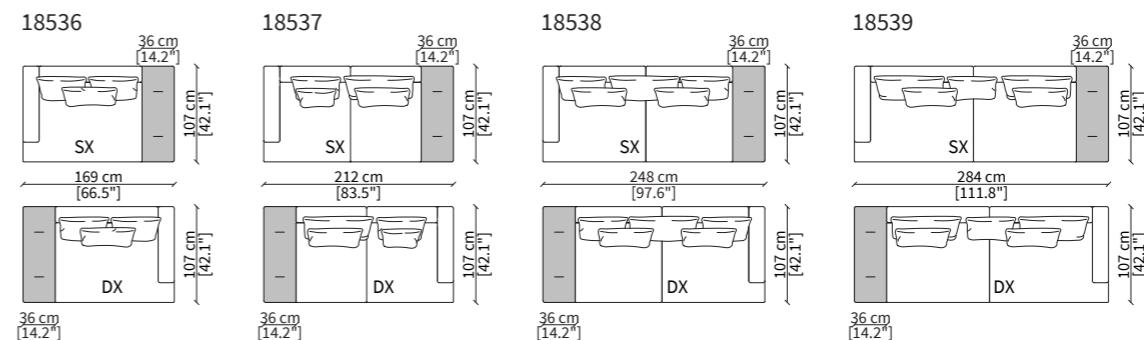

ELEMENTI CENTRALI TOP / CENTRAL TOP ELEMENTS

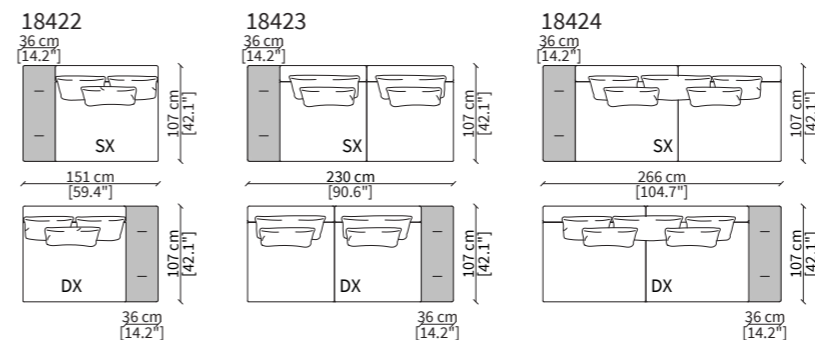

Dimensioni espresse in cm se non diversamente indicato.
L'Azienda si riserva il diritto di apportare modifiche ai modelli senza preavviso.
Tolleranza sulle misure indicate di +/- 2%.

Dimensions in centimeter if not differently indicated.
The Company reserves the right to change the models without any advance notice.
Tolerance on the given sizes +/- 2%.

HORIZON LARGE SOFA Design Christophe Pillet

ELEMENTI CENTRALI DORMEUSE POUF TOP / CENTRAL DORMEUSE POUF TOP ELEMENTS

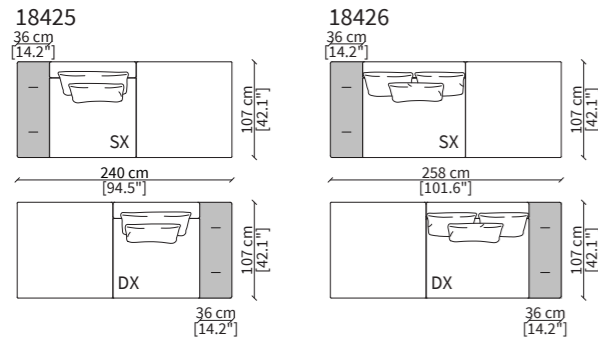

ELEMENTO POUF TOP / POUF TOP ELEMENT

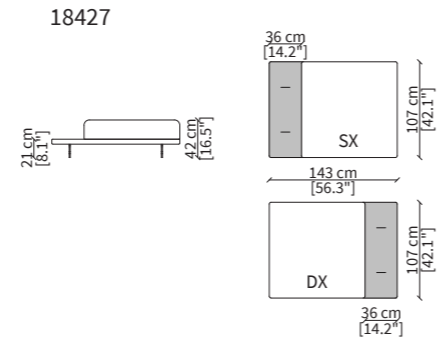

SERVER



POGGIA-TESTA / HEAD-REST

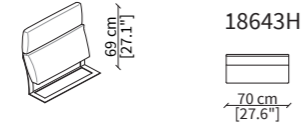

VOLUMI / VOLUMES

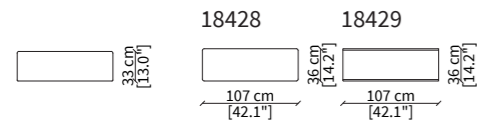

Dimensioni espresse in cm se non diversamente indicato.
L'Azienda si riserva il diritto di apportare modifiche ai modelli senza preavviso.
Tolleranza sulle misure indicate di +/- 2%.

Dimensions in centimeter if not differently indicated.
The Company reserves the right to change the models without any advance notice.
Tolerance on the given sizes +/- 2%.

HORIZON LARGE SOFA Design Christophe Pillet

ESEMPI DI COMPOSIZIONE AD ANGOLO / EXAMPLES OF CORNER COMPOSITIONS

Le composizioni ad angolo possono essere così realizzate:
Corner composition can be built as follows:

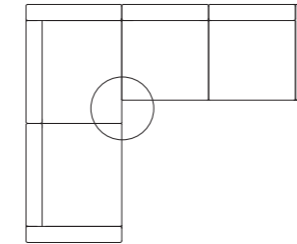

1. accostando tra loro gli elementi.
Suggeriamo l'aggiunta di un cuscino schienale per maggior comfort.

1. by combining the elements.
We recommend adding an extra back cushion for a better comfort.

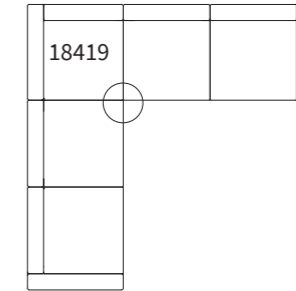

2. utilizzando l'angolo (art. **18419**) per un allineamento preciso delle sedute.

2. by using the corner (art. **18419**) for a perfect alignment of the seats.

ESEMPI DI COMPOSIZIONE CON DORMEUSE GEOMETRICA / EXAMPLES OF COMPOSITION WITH GEOMETRICAL DORMEUSE

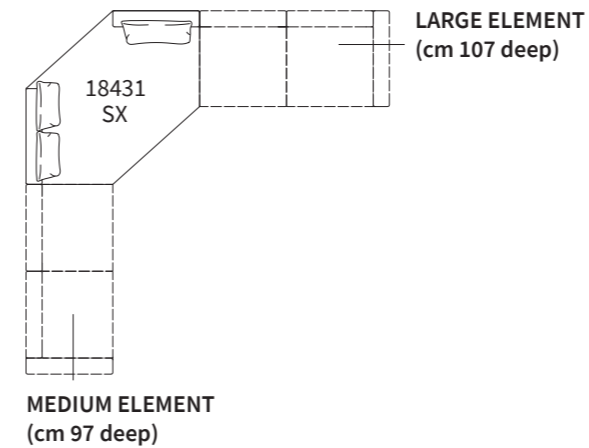

La dormeuse geometrica viene usata come elemento di connessione tra elementi Horizon Medium (che devono essere usati sul lato profondo cm 97) ed elementi Horizon Large (che devono essere usati sul lato profondo cm 107).

The geometrical dormeuse is used as connection between Horizon Medium elements (to be joined on the side cm 97 deep) and Horizon Large elements (to be joined on the side cm 107 deep).

Dimensioni espresse in cm se non diversamente indicato.
L'Azienda si riserva il diritto di apportare modifiche ai modelli senza preavviso.
Tolleranza sulle misure indicate di +/- 2%.

Dimensions in centimeter if not differently indicated.
The Company reserves the right to change the models without any advance notice.
Tolerance on the given sizes +/- 2%.

HORIZON LARGE SOFA Design Christophe Pillet

COMPOSIZIONE 1 / COMPOSITION 1

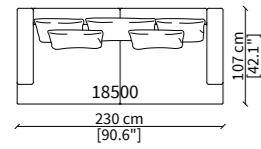

CODICI / CODES: **18500**

COMPOSIZIONE 2 / COMPOSITION 2

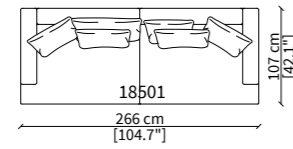

CODICI / CODES: **18501**

COMPOSIZIONE 3 / COMPOSITION 3

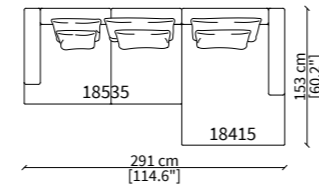

CODICI / CODES: **18535, 18415**

COMPOSIZIONE 4 / COMPOSITION 4

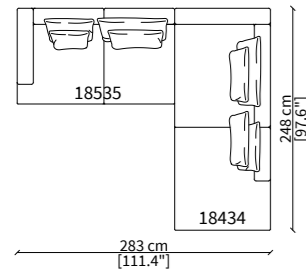

CODICI / CODES: **18535, 18434**

COMPOSIZIONE 5 / COMPOSITION 5

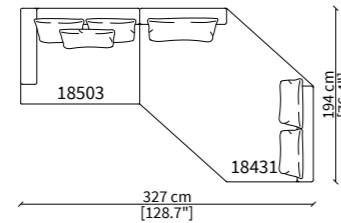

CODICI / CODES: **18503, 18431**

COMPOSIZIONE 6 / COMPOSITION 6

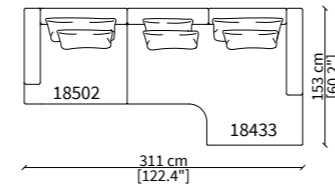

CODICI / CODES: **18502, 18433**

COMPOSIZIONE 7 / COMPOSITION 7

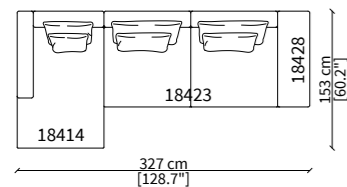

CODICI / CODES: **18414, 18423, 18428**

COMPOSIZIONE 8 / COMPOSITION 8

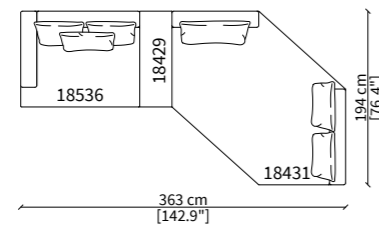

CODICI / CODES: **1536, 18429, 18431**

COMPOSIZIONE 9 / COMPOSITION 9

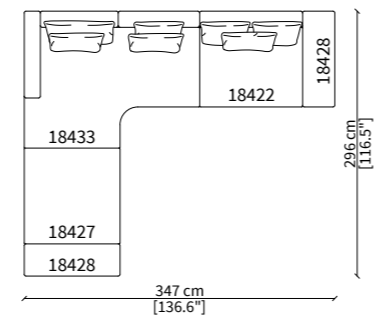

CODICI / CODES: **18428, 18427, 18433, 18422, 18428**

Dimensioni espresse in cm se non diversamente indicato.
L'Azienda si riserva il diritto di apportare modifiche ai modelli senza preavviso.
Tolleranza sulle misure indicate di +/- 2%.

Dimensions in centimeter if not differently indicated.
The Company reserves the right to change the models without any advance notice.
Tolerance on the given sizes +/- 2%.

HORIZON LARGE SOFA Design Christophe Pillet

COMPOSIZIONE 10 / COMPOSITION 10

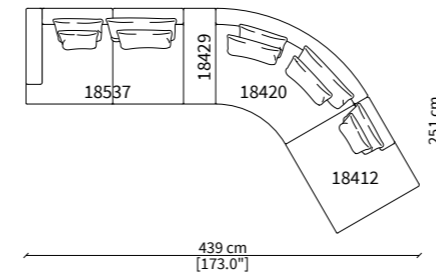

CODICI / CODES: **18537, 18429, 18420, 18412**

COMPOSIZIONE 11 / COMPOSITION 11

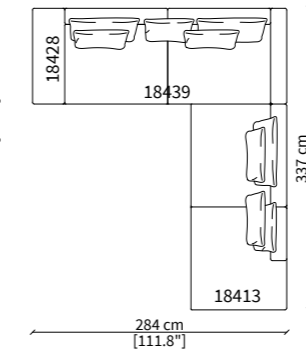

CODICI / CODES: **18428, 18439, 18413**

COMPOSIZIONE 12 / COMPOSITION 12

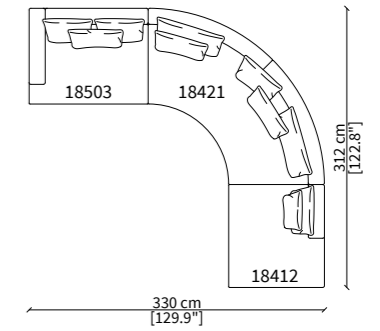

CODICI / CODES: **18503, 18421, 18412**

Dimensioni espresse in cm se non diversamente indicato.
L'Azienda si riserva il diritto di apportare modifiche ai modelli senza preavviso.
Tolleranza sulle misure indicate di +/- 2%.

Dimensions in centimeter if not differently indicated.
The Company reserves the right to change the models without any advance notice.
Tolerance on the given sizes +/- 2%.

Per la gamma completa di materiali è possibile consultare il nostro sito web www.frigerio.com
The full range of materials can be found on our website at www.frigerio.com.

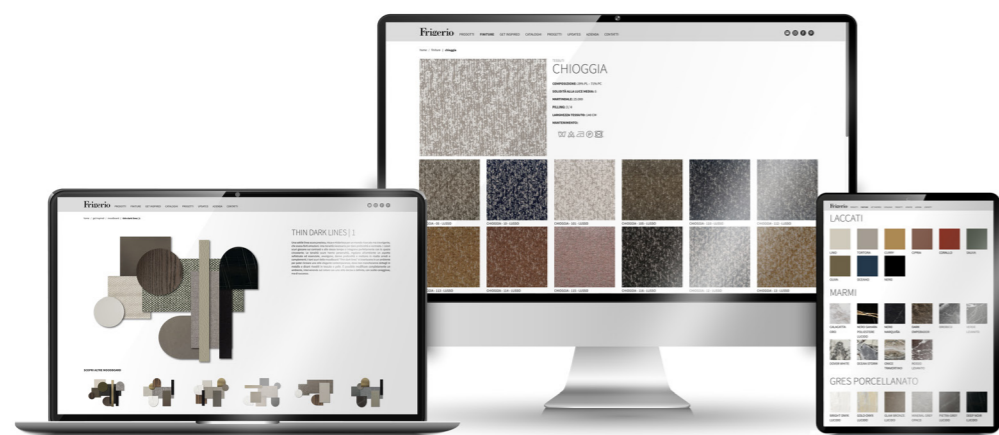

WWW.FRIGERIO.COM

Frigerio

Via Sant'Agata 63
22066 Mariano Comense (CO) - Italy
Tel. +39 031 5481225
info@frigerio.com
www.frigerio.com