

Frigerio

EDDIE SOFA

Design R&D Frigerio

Eddie è una collezione di divani modulari a terra con basamento in legno rivestito in pelle o tessuto e piedini a scomparsa. La sottile base sostiene il cuscino monovolume della seduta, che può essere rivestito con tessuto o pelle con lavorazione liscia oppure con una particolare trapuntatura orizzontale che scorre lungo la seduta. Il divano Eddie, dal gusto contemporaneo ed elegante, è disponibile nelle classiche soluzioni di divano lineare e angolare, ma anche in inaspettate soluzioni d'arredo bifacciali per dare vita a forme uniche e dalle proporzioni calibrate. Il dettaglio del sottile basamento su cui poggia ne esalta la cura per i particolari per un risultato scenografico. Eddie è un divano dalle linee essenziali che si inserisce facilmente in diversi ambienti domestici.

Eddie is a collection of modular floor-standing sofas with a wooden base covered in leather or fabric and concealed feet. The slim base supports the monovolume seat cushion, which can be covered with fabric or leather with plain pattern or worked with a special horizontal quilting running along the seat. The Eddie sofa, an elegant and contemporary modular sofa, is available in classic linear and corner solutions, but also in unexpected double-sided furnishing solutions to create unique forms with balanced proportions. The detail of the slim base on which it rests, enhances the company's attention to detail. Eddie is a sofa with essential lines that fits easily into different home environments.

EDDIE

Struttura: legno multistrato imbottito in poliuretano espanso indeformabile rivestito in fibra termo-legata accoppiata a fibra di cotone.

Basamento: nello stesso materiale e colore del rivestimento, fisso sia in tessuto che in pelle.

Bracciolo: il modello presenta due diverse tipologie di bracciolo, entrambe profonde come il divano. La versione Low armrest ha il bracciolo più basso dello schienale. La versione High armrest ha il bracciolo alto quanto lo schienale.

Rivestimento: sfoderabile in tessuto, fisso in pelle. È necessario smontare il basamento per sfoderare gli elementi. Rivestimento cuscino seduta disponibile nella versione liscia (PLAIN) o nella versione trapuntata (QUILT).

Profilo: stesso materiale e colore del rivestimento. Su richiesta profilo in contrasto in Grosgrain.

ACCESSORI:

| **volumi:** elementi volumi con struttura in multistrato di legno imbottito con basamento nello stesso materiale del rivestimento, fisso. Rivestimento sfoderabile in tessuto o pelle e profilo nello stesso materiale e colore. Su richiesta profilo in contrasto in Grosgrain.

| **tavolini:** impiallacciato frassino colore Wengé, Tabacco, Greige, Sabbia o Liquirizia. Oppure in colore laccato.

Structure: plywood padded with non-deformable polyurethane foam covered with thermo-bonded fibre doubled with cotton fibre.

Base: in the same material and colour as the cover, fix either in fabric or leather.

Armrest: the model features two different kinds of armrest, both as deep as the sofa. In the Low armrest version, the armrest is lower than the backrest. In the High armrest version, the armrest is as high as the backrest.

Cover: removable in fabric, fix in leather. It's necessary to disassemble the base to remove the cover. The cover of the seat cushion is available in the PLAIN version or in the version with horizontal quilting, QUILT.

Piping: in the same material and colour as the cover. On demand piping in contrast in Grosgrain.

ACCESSORIES:

| **volume:** volume elements with structure in plywood padded with base in the same material of the cover, fixed. Cover removable in fabric or leather and piping in the same material and colour. On demand piping in contrast in Grosgrain.

| **small table:** veneered ashwood Wengé, Tobacco, Greige, Sand or Liquorice colour. Or in lacquered colours.

EDDIE DOUBLE

Versione con elementi Seduta che consentono la realizzazione di composizioni bifacciali.

Viste le caratteristiche tecniche degli elementi Seduta, questi non possono essere utilizzati singolarmente, ma solamente in composizioni bifacciali.

Version with Seat elements to create double-side compositions. Due to the technical characteristics of the Seat elements, they cannot be used as free-standing, but only in double-sided compositions.



EDDIE BRACCIOLI E SEDUTE / ARMRESTS AND SEATS



BRACCIOLO BASSO / LOW ARMREST

La versione **Low armrest** ha il bracciolo più basso dello schienale, H. 59 cm.

In the **Low armrest** version, the armrest is lower than the backrest, H. 59 cm.

BRACCIOLO ALTO / HIGH ARMREST

La versione **High armrest** ha il bracciolo alto quanto lo schienale, H. 71 cm.

In the **High armrest** version, the armrest is as high as the backrest, H. 71 cm.



SEDUTA LISCIA / PLAIN SEAT

Ogni elemento seduta presenta un rivestimento liscio.

Each seating element has a plain cover.

SEDUTA TRAPUNTATA / QUILTED SEAT

Ogni elemento seduta presenta una trapuntatura orizzontale.

Each seating element features a horizontal quilting.

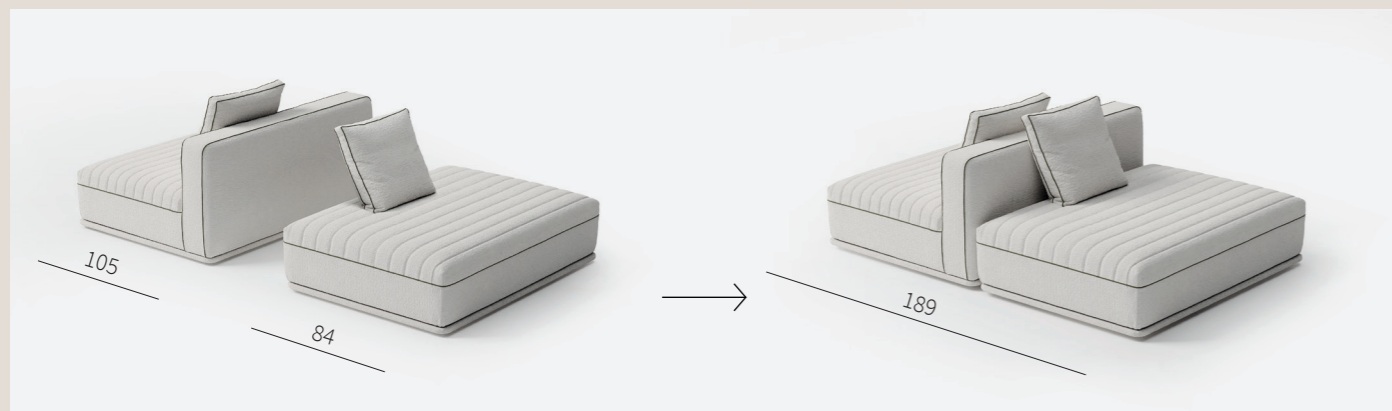

EDDIE DOUBLE

Gli elementi della collezione permettono l'aggancio degli articoli "Seduta", consentendo la realizzazione di composizioni bifacciali.

The elements of the collection allow the fixing of "Seat elements" to create double-side compositions.

EDDIE ACCESSORI / ACCESSORIES



VOLUME / VOLUME

Elementi di varie dimensioni con basamento e rivestimento in tessuto o pelle da usare come elemento integrato o freestanding.

Element of different sizes with base and cover in fabric or leather to be used as integrated element or freestanding.

TAVOLINO / SMALL TABLE

Tavolini di diverse dimensioni in laccato o legno da utilizzare come elemento integrato o freestanding.

Small tables in different sizes in lacquered colours or wood to be used as integrated element or as a freestanding piece.



BASAMENTO IN PELLE / LEATHER BASE

Basamento del divano rivestito in pelle, non sfoderabile.

Base of the sofa in leather, fixed cover.

BASAMENTO IN TESSUTO / FABRIC BASE

Basamento in tessuto nello stesso materiale e colore del rivestimento; non sfoderabile.

Base in fabric in the same material and colour of the cover; fixed cover.



PROFILO / PIPING

Profilo nello stesso materiale e colore del rivestimento. Su richiesta disponibile in contrasto nella finitura Grosgrain.

Piping in the same material and colour of the cover. On demand in contrast in the finish Grosgrain.

EDDIE SOFA Design R&D Frigerio

B BRACCIOLO BASSO / LOW ARMREST / h. 59 cm

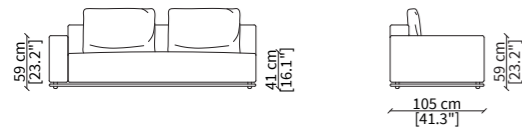

A BRACCIOLO ALTO / HIGH ARMREST / h. 71 cm

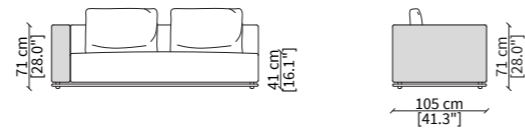

DIVANI / SOFAS

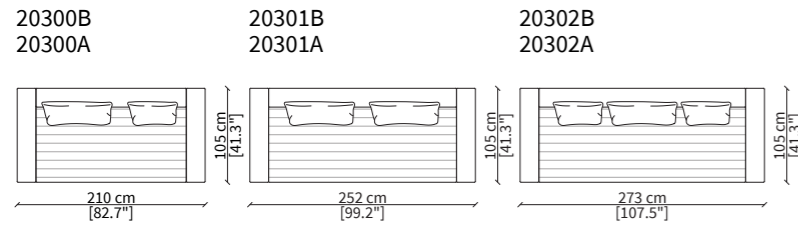
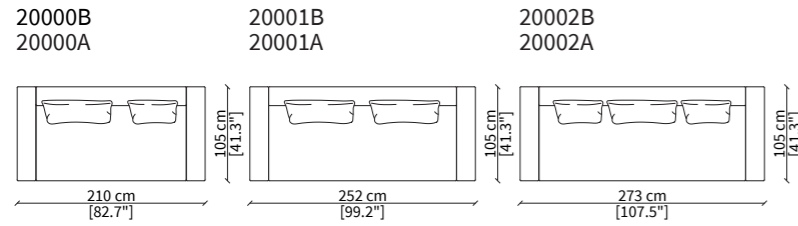

ELEMENTI TERMINALI / TERMINAL ELEMENTS

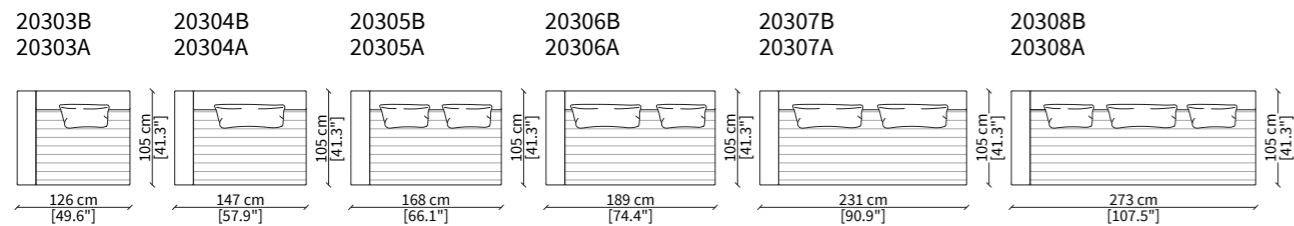
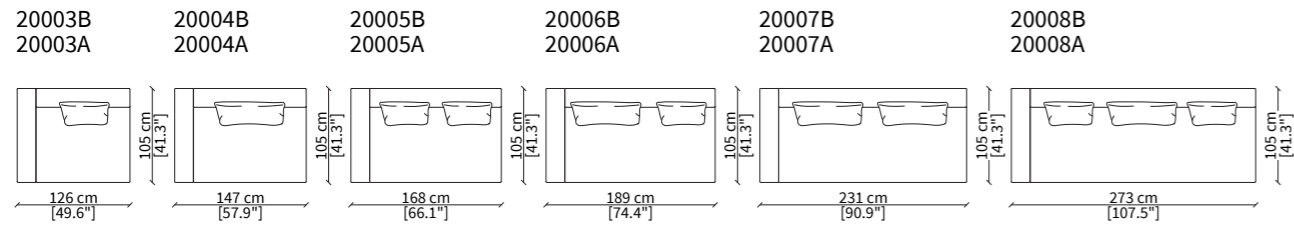

Dimensioni espresse in cm se non diversamente indicato.
L'Azienda si riserva il diritto di apportare modifiche ai modelli senza preavviso.
Tolleranza sulle misure indicate di +/- 2%.

Dimensions in centimeter if not differently indicated.
The Company reserves the right to change the models without any advance notice.
Tolerance on the given sizes +/- 2%.

EDDIE SOFA Design R&D Frigerio

ELEMENTI CENTRALI / CENTRAL ELEMENTS

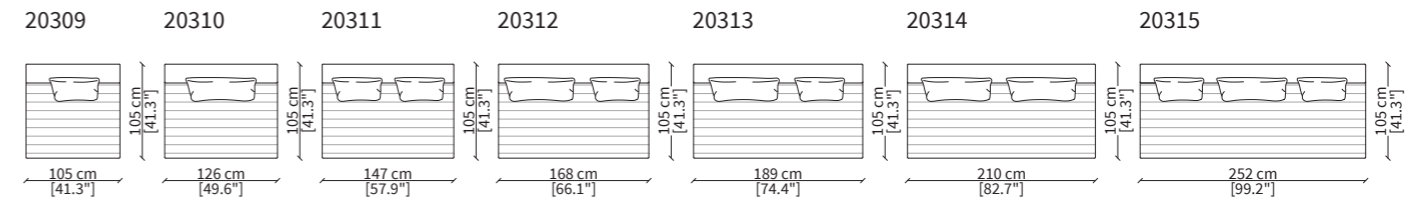
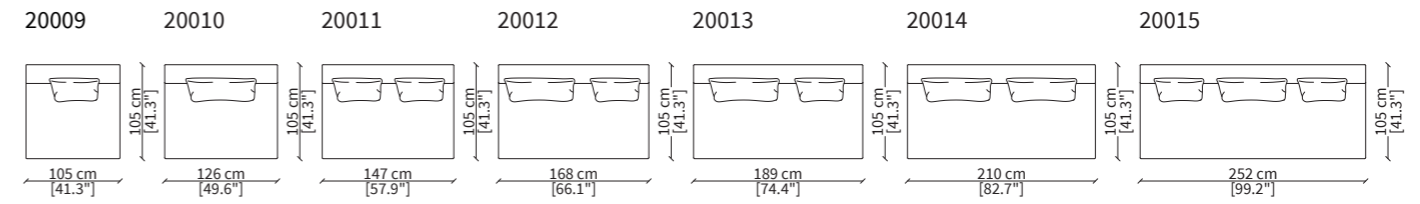

ELEMENTI DORMEUSE / DORMEUSE ELEMENTS

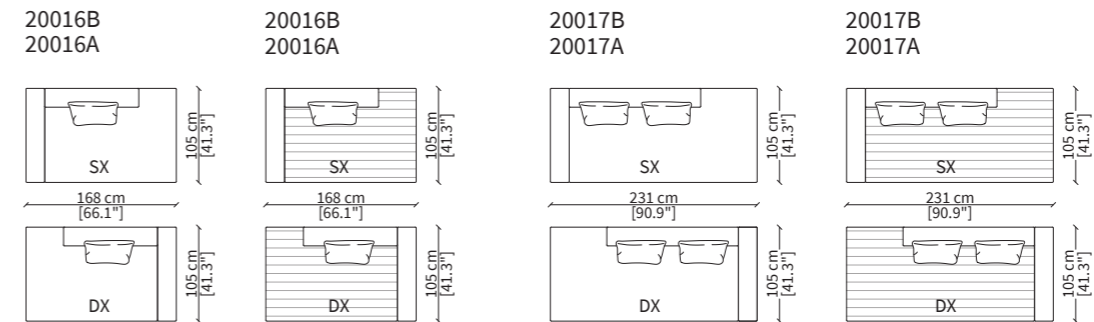

ELEMENTI CENTRALI DORMEUSE / CENTRAL DORMEUSE ELEMENTS

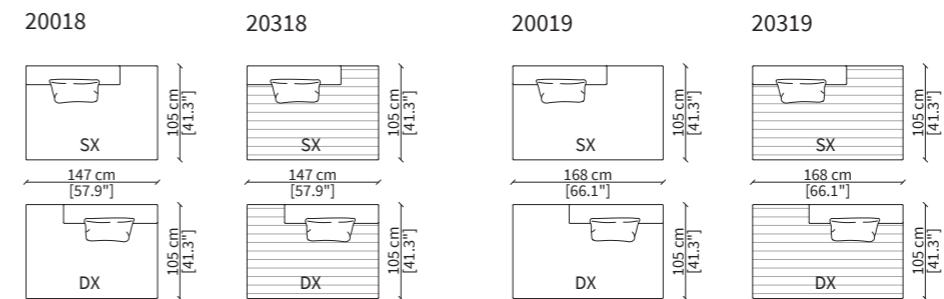

Dimensioni espresse in cm se non diversamente indicato.
L'Azienda si riserva il diritto di apportare modifiche ai modelli senza preavviso.
Tolleranza sulle misure indicate di +/- 2%.

Dimensions in centimeter if not differently indicated.
The Company reserves the right to change the models without any advance notice.
Tolerance on the given sizes +/- 2%.

EDDIE SOFA Design R&D Frigerio

CHAISES LONGUE

20023B
20023A

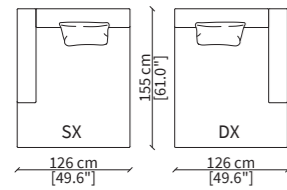

20323B
20323A

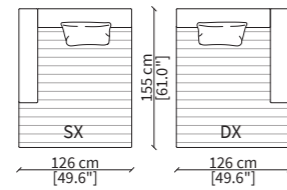

CHAISES LONGUE CENTRALI / CENTRAL CHAISES LONGUE

20022

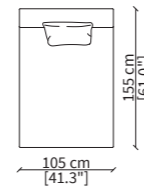

20322

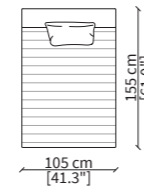

ELEMENTI TERMINALI COMFORT / COMFORT TERMINAL ELEMENTS

20038B
20038A

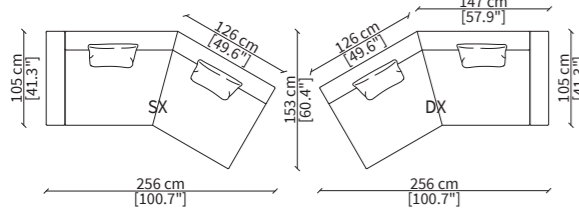

20338B
20338A

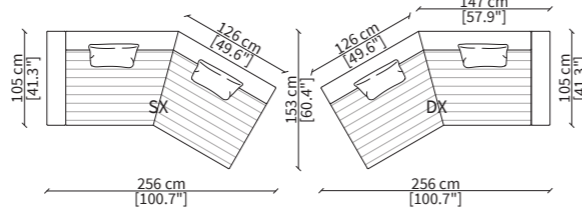

ELEMENTI CENTRALI COMFORT / COMFORT CENTRAL ELEMENTS

20020

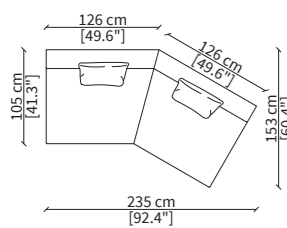

20320

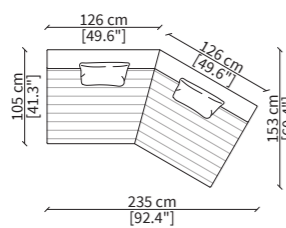

ELEMENTI DORMEUSE COMFORT / COMFORT DORMEUSE ELEMENTS

20021

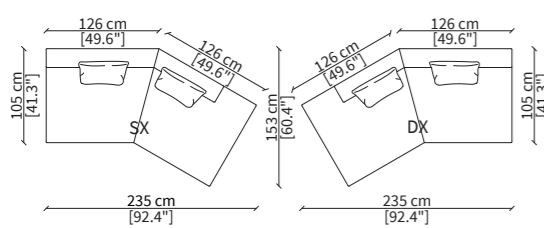

20321

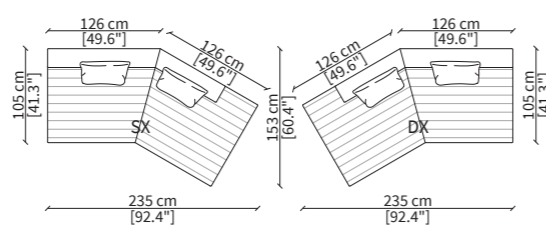

ELEMENTI ANGOLO / CORNER ELEMENTS

20024

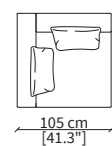

20324

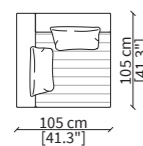

Dimensioni espresse in cm se non diversamente indicato.
L'Azienda si riserva il diritto di apportare modifiche ai modelli senza preavviso.
Tolleranza sulle misure indicate di +/- 2%.

Dimensions in centimeter if not differently indicated.
The Company reserves the right to change the models without any advance notice.
Tolerance on the given sizes +/- 2%.

EDDIE SOFA Design R&D Frigerio

ELEMENTI SEDUTA PER EDDIE DOUBLE / SEAT ELEMENTS FOR EDDIE DOUBLE

B BRACCIOLLO BASSO / LOW ARMREST / h. 59 cm

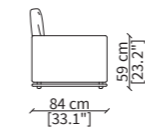
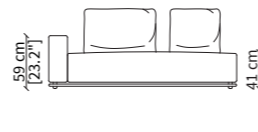

A BRACCIOLLO ALTO / HIGH ARMREST / h.71 cm

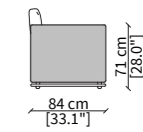
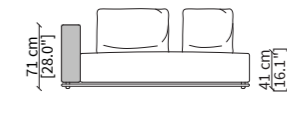

ELEMENTI SEDUTA TERMINALE / TERMINAL SEAT ELEMENTS

20025B
20025A

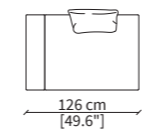

20026B
20026A

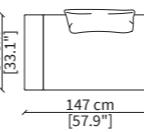

20027B
20027A

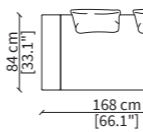

20028B
20028A

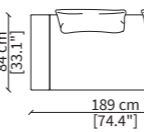

20029B
20029A

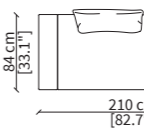

20325B
20325A

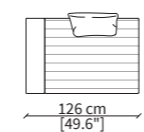

20326B
20326A

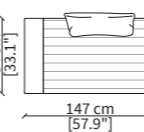

20327B
20327A

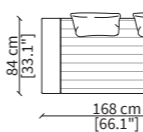

20328B
20328A

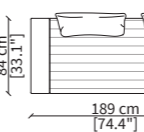

20329B
20329A

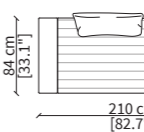

ELEMENTI SEDUTA CENTRALI / CENTRAL SEAT ELEMENTS

20030

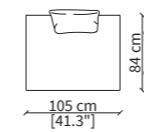

20031

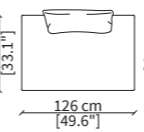

20032

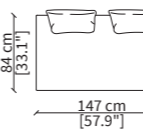

20033

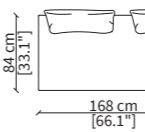

20034

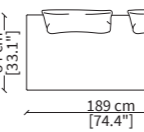

20035

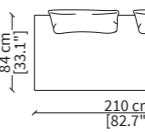

20330

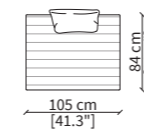

20331

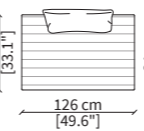

20332

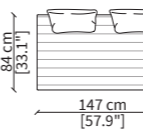

20333

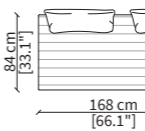

20334

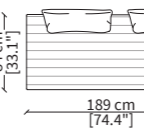

20335

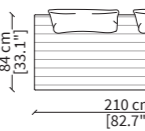

ELEMENTI SEDUTA CHAISE LONGUE / CHAISE LONGUE SEAT ELEMENTS

20037B
20037A

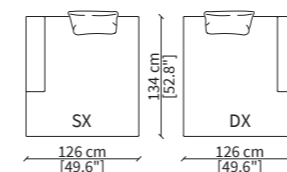

20337B
20337A

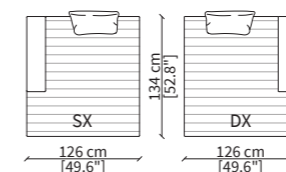

ELEMENTI SEDUTA CENTRALI CHAISE LONGUE / CENTRAL CHAISE LONGUE SEAT ELEMENTS

20036

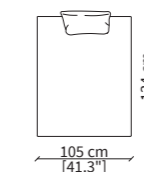

20336

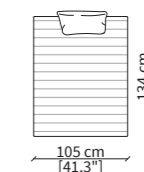

Dimensioni espresse in cm se non diversamente indicato.
L'Azienda si riserva il diritto di apportare modifiche ai modelli senza preavviso.
Tolleranza sulle misure indicate di +/- 2%.

Dimensions in centimeter if not differently indicated.
The Company reserves the right to change the models without any advance notice.
Tolerance on the given sizes +/- 2%.

EDDIE SOFA
Design R&D Frigerio

POUFS

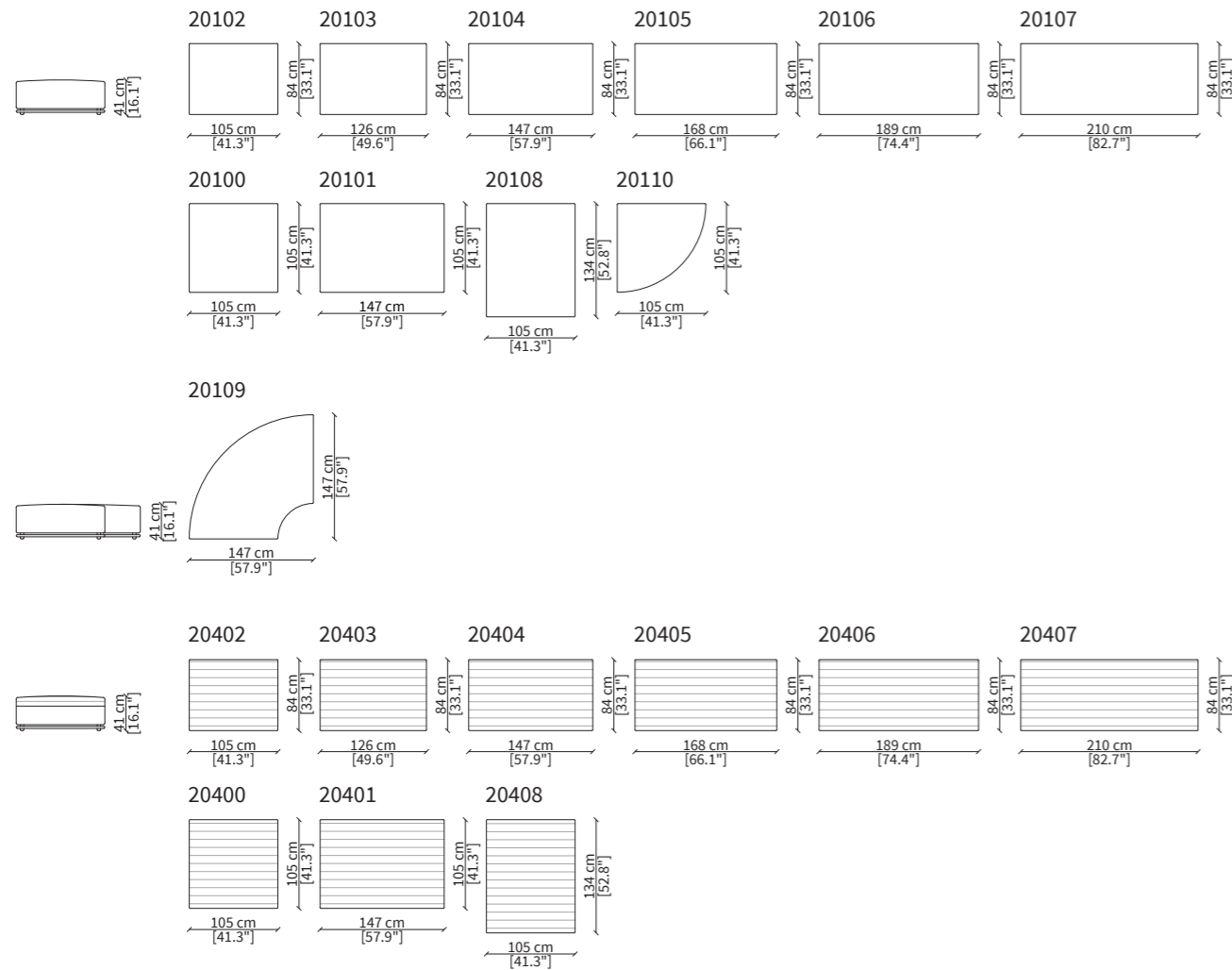

VOLUMI / VOLUMES

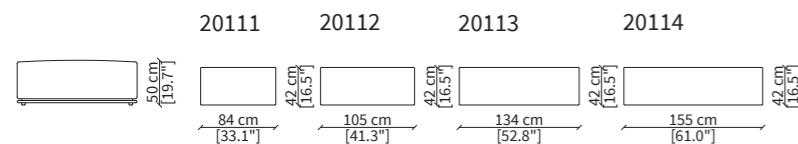

TAVOLINI / SMALL TABLES

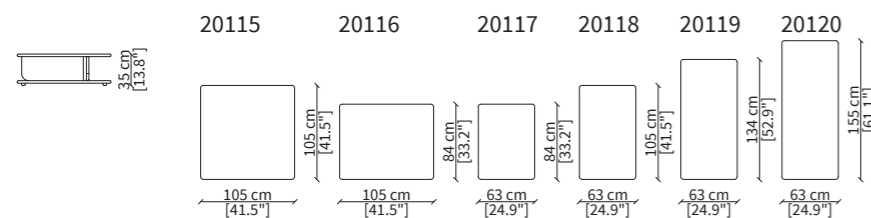

Dimensioni espresse in cm se non diversamente indicato.
L'Azienda si riserva il diritto di apportare modifiche ai modelli senza preavviso.
Tolleranza sulle misure indicate di +/- 2%.

Dimensions in centimeter if not differently indicated.
The Company reserves the right to change the models without any advance notice.
Tolerance on the given sizes +/- 2%.

EDDIE SOFA
Design R&D Frigerio

ESEMPI DI COMPOSIZIONE AD ANGOLO CON BRACCIOLO BASSO / EXAMPLES OF CORNER COMPOSITIONS WITH LOW ARMREST

Le composizioni ad angolo possono essere così realizzate:
Corner composition can be built as follows:

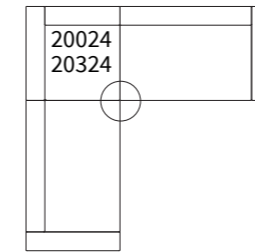

1. utilizzando l'angolo (art. **20024** o **20324**) per un allineamento preciso delle sedute.

1. by using the corner (art. **20024** or **20324**) for a perfect alignment of the seats.

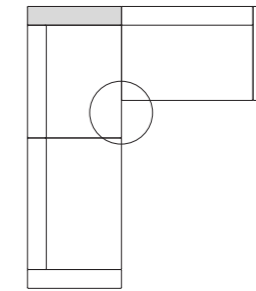

2. utilizzando un terminale con bracciolo alto per creare un angolo. Sugeriamo l'aggiunta di un cuscino schienale per maggior comfort.

2. by using a terminal with high armrest to create a corner. We recommend adding an extra back cushion for a better comfort.

ESEMPI DI COMPOSIZIONE AD ANGOLO CON BRACCIOLO ALTO / EXAMPLES OF CORNER COMPOSITIONS WITH HIGH ARMREST

Le composizioni ad angolo possono essere così realizzate:
Corner composition can be built as follows:

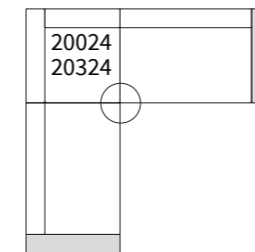

1. utilizzando l'angolo (art. **20024** o **20324**) per un allineamento preciso delle sedute.

1. by using the corner (art. **20024** or **20324**) for a perfect alignment of the seats.

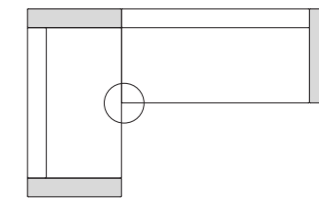

2. accostando tra loro gli elementi con bracciolo alto. Sugeriamo l'aggiunta di un cuscino schienale per maggior comfort.

2. by combining the elements with high armrest. We recommend adding an extra back cushion for a better comfort.

Dimensioni espresse in cm se non diversamente indicato.
L'Azienda si riserva il diritto di apportare modifiche ai modelli senza preavviso.
Tolleranza sulle misure indicate di +/- 2%.

Dimensions in centimeter if not differently indicated.
The Company reserves the right to change the models without any advance notice.
Tolerance on the given sizes +/- 2%.

EDDIE SOFA
Design R&D Frigerio

COMPOSIZIONE 1 / COMPOSITION 1

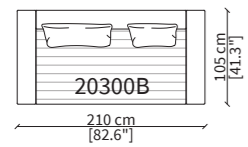

CODICI / CODES: **20300B**

COMPOSIZIONE 2 / COMPOSITION 2

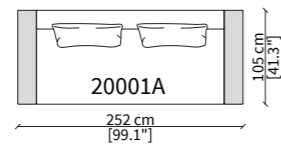

CODICI / CODES: **20001A**

COMPOSIZIONE 3 / COMPOSITION 3

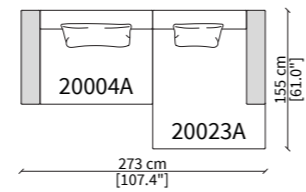

CODICI / CODES: **20004A, 20023A**

COMPOSIZIONE 4 / COMPOSITION 4

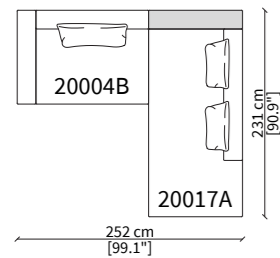

CODICI / CODES: **20004B, 20017A**

COMPOSIZIONE 5 / COMPOSITION 5

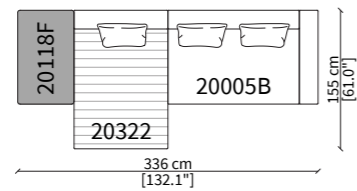

CODICI / CODES: **20118F, 20322, 20005B**

COMPOSIZIONE 6 / COMPOSITION 6

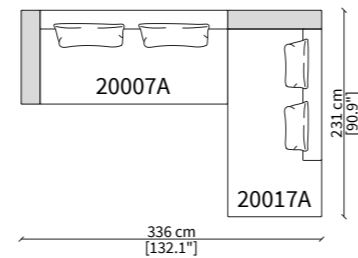

CODICI / CODES: **20007A, 20017A**

COMPOSIZIONE 7 / COMPOSITION 7

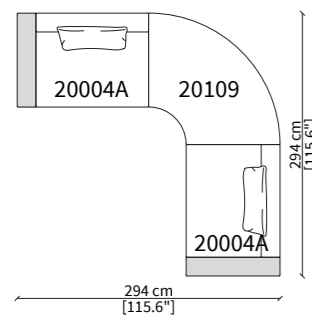

CODICI / CODES: **20004A x 2, 20109**

COMPOSIZIONE 8 / COMPOSITION 8

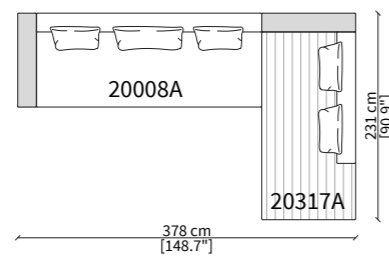

CODICI / CODES: **20008A, 20317A**

COMPOSIZIONE 9 / COMPOSITION 9

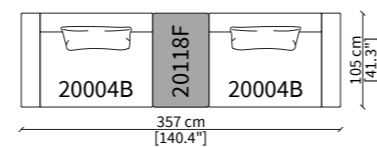

CODICI / CODES: **20004B x 2, 20118F**

Dimensioni espresse in cm se non diversamente indicata.
L'Azienda si riserva il diritto di apportare modifiche ai modelli senza preavviso.
Tolleranza sulle misure indicate di +/- 2%.

Dimensions in centimeter if not differently indicated.
The Company reserves the right to change the models without any advance notice.
Tolerance on the given sizes +/- 2%.

EDDIE SOFA
Design R&D Frigerio

COMPOSIZIONE 10 / COMPOSITION 10

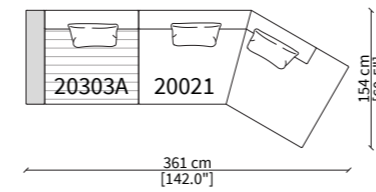

CODICI / CODES: **20303A, 20021**

COMPOSIZIONE 11 / COMPOSITION 11

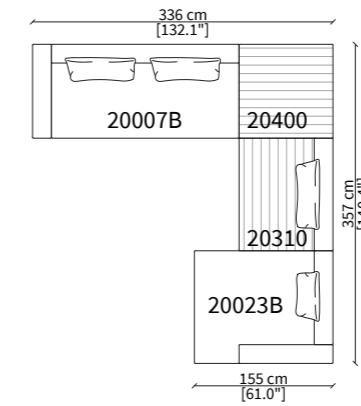

CODICI / CODES: **20007B, 20400, 20310, 20023B**

COMPOSIZIONE 12 / COMPOSITION 12

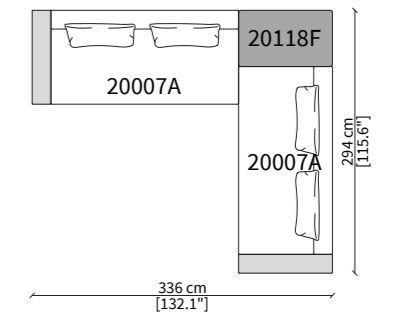

CODICI / CODES: **20007A x 2, 20118F**

COMPOSIZIONE 13 / COMPOSITION 13

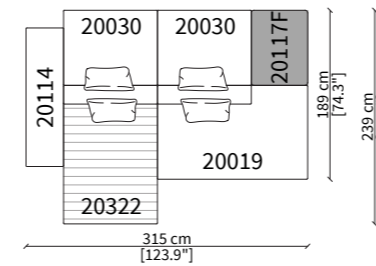

CODICI / CODES: **20114, 20030 x 2, 20117F, 20322, 20019**

COMPOSIZIONE 14 / COMPOSITION 14

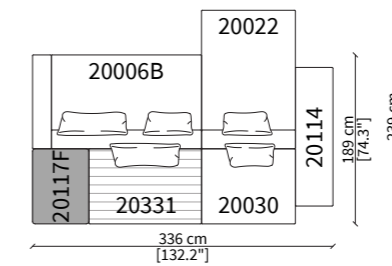

CODICI / CODES: **20006B, 20022, 20114, 20117F, 20331, 20030**

COMPOSIZIONE 15 / COMPOSITION 15

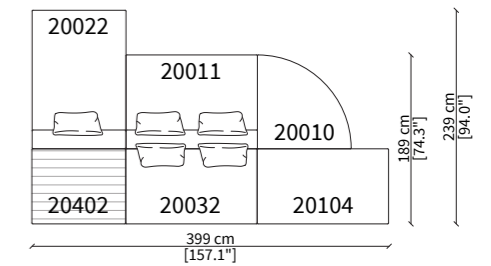

CODICI / CODES: **20022, 20011, 20010, 20402, 20032, 20104**

COMPOSIZIONE 16 / COMPOSITION 16

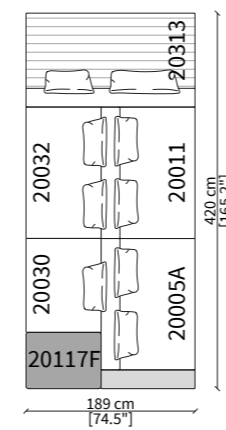

CODICI / CODES: **20117F, 20030, 20032, 20005A, 20011, 20313**

COMPOSIZIONE 17 / COMPOSITION 17

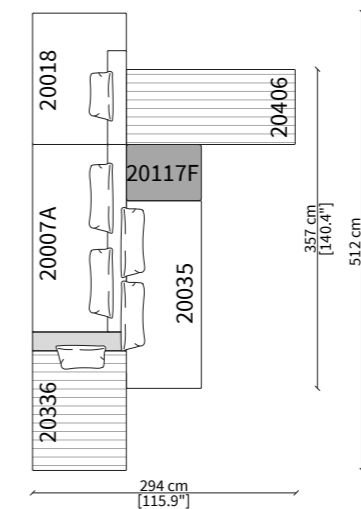

CODICI / CODES: **20336, 20007A, 20018, 20035, 20117F, 20406**

COMPOSIZIONE 18 / COMPOSITION 18

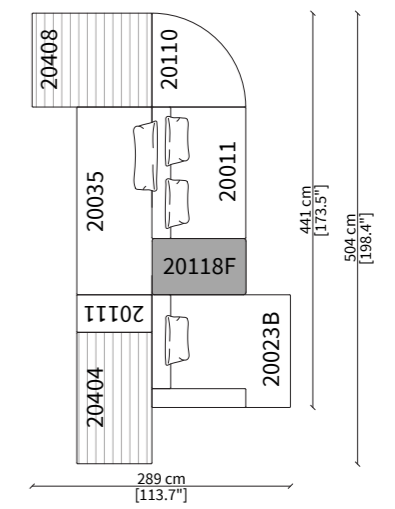

CODICI / CODES: **20404, 20111, 20035, 20408, 20023B, 20118F, 20011, 20110**

Per la gamma completa di materiali è possibile consultare il nostro sito web www.frigerio.com
The full range of materials can be found on our website at www.frigerio.com.

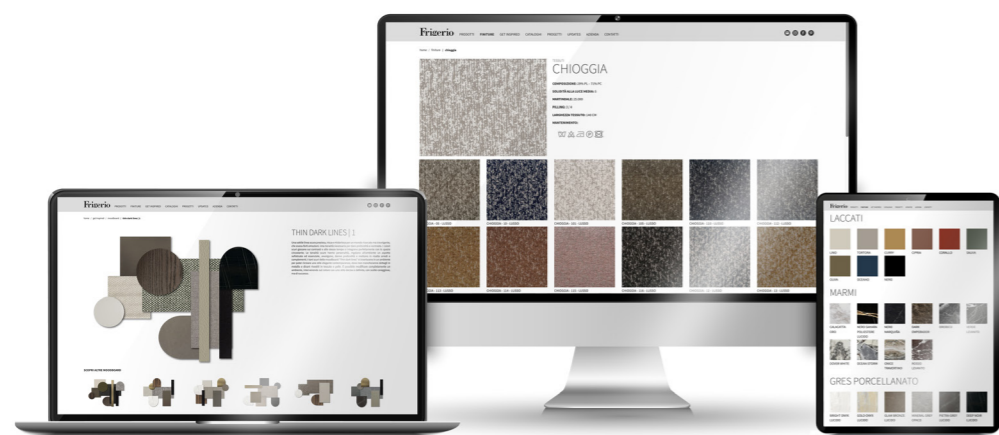

WWW.FRIGERIO.COM

Frigerio

Via Sant'Agata 63
22066 Mariano Comense (CO) - Italy
Tel. +39 031 5481225
info@frigerio.com
www.frigerio.com